

Characteristics:

- Electrical Life: 50,000 cycles (sea level to 80,000 feet)
- Mechanical Life: 100,000 cycles
- Acceleration: 15 g's
- Shock: 25 g's

- Ambient Temperature Class:
 - B -70°C to 125°C
 - D -70°C to 71°C
- Hermetically sealed/ MIL-PRF-6106
- Twin Break Silver Alloy Main Contacts

- Vibration Levels (Typical):

5 - 10 CPS .08 DA	10 - 55 CPS .06 DA	55 - 200CPS 10 g's
250 - 500 CPS 5 g's	500 - 1500 CPS 3 g's	

Typical Configurations

Catalog Number	Continuous Ampere Contact Rating	Poles and Throw	Operating Coil Voltage	Number Aux ^① Contacts	Dimension Drawing Figure Number	Wiring Diagram Figure Number	Government Type Number	Temp Class/ Note
6042H110-2	12	3PST	28 Vdc	1	2	8	MS24143-D3	B ^②
6042H141-2	25	3PST		—	2	6	MS24143-D1	B
6042H142-2				1	2	8	MS24143-D2	B ^②
6042H290-2			115 Vac 60 or 400 Hertz	—	2	6	MS24143-A3	D
6042H291-2			Built In Rectifiers	1	2	8	MS24143-A4	D
6042H155-2	50	SPST	28 Vdc	—	1	9	MS24140-D1	B
6042H156-2				1	1	10	MS24140-D2	B
6042H145-2				—	2	6	MS24376-D1	B
6042H146-2				1	2	8	MS24376-D2	B
6042H147-2		3PST	115 Vac 60 or 400 Hertz	—	2	6	MS24376-A1	B ^③
6042H148-2				1	2	8	MS24376-A2	B ^③
6042H285-2				1	2	8	MS24376-A4	B ^③
6042H288-2				—	2	6	MS24376-A3	B ^③



Cat. No. 6042H285
3PST, 50 Amp w/Auxiliary



Cat. No. 6042H155
SPST, 50 Amp



Cat. No. 6042H46
SPST, 50 Amp w/Auxiliary

POWER RELAYS — HERMETICALLY SEALED - 12 AMPS TO 50 AMPS

Ratings

Power Contact Ratings - Continuous Duty ^①						Coil Data					Catalog Number		
28 Vdc			115/200 Vac 400 Hz			Max. Coil Power		Max. Volts Pick Up at Amb. Temp.	Volts				
Amperes			Amperes			Amps	Volts		Hold	Drop Out			
Res.	Ind.	Motor	Res.	Ind.	Motor								
12	12	6	12	12	6	0.6	29 dc	18 dc	7 dc	1.5 dc	6042H110-2		
25	25	25	25	25	25						0.6	0.225	124 ac
						0.6	6042H142-2						
			50 ^③	50 ^③	50 ^③	0.50	29 dc	18 dc	7 dc	1.5 dc	6042H290-2		
0.50	6042H291-2												
50	50	50	50	50	50	0.6	0.6	0.225	124 ac	90 ac	40 ac	10 ac	6042H155-2
													0.6
			50	50	50	0.225	124 ac	90 ac	40 ac	10 ac	6042H145-2		
													6042H146-2
													6042H147-2
													6042H148-2
													6042H285-2
													6042H288-2

- ① Auxiliary Switch: SPDT rated 28 Vdc and 115 V 400 Hz, 5 Amp Res. & Ind. & 0.75 Amp Lamp
- ② Rated 100,000 operations electrical and mechanical life; Auxiliary switch rated 1,25 Amp Res. & 0.75 Amp Ind.
- ③ These Ratings for 115 V 400 Hz only
- ④ See MS Sheets for details
- ⑤ Intermittent duty ratings for general applications. (See chart below)
- ⑥ Ratings for 50/60 Hz only @ 115/200 Vac
- ⑦ 400 Hz only
- ⑧ Temperature Class D for 60 Hz AC Operation

Intermittent Duty Ratings

Continuous	15 Minutes	5 Minutes	1 Minute	Max. Inrush
100%	130%	150%	200%	600%

In general, these power relays can withstand the above intermittent duty overcurrent.

Options:

Internal Coil Suppression

Typical Configurations

Catalog Number	Continuous Ampere Contact Rating	Poles and Throw	Operating Coil Voltage	Number Aux. ^① Contacts	Dimension Drawing Figure Number	Wiring Diagram Figure Number	Government Type Number	Temp Class/ Note	Power Contact Ratings — Continuous Duty ^②						Max. Time In Seconds		Coil Data			Volts	
									28 Vdc Amperes			115/200 Vac 400 Hz Amperes			Operate	Release	Amps	Volts	Max. Volts Pick-up @ Amb Temp.	Hold	Drop Out
									Res.	Ind.	Motor	Res.	Ind.	Motor							
6042H159-2	100	SPST	28 Vdc	—	1	9	MS24141-D1	B	100	100	100	100 ^③	—	75 ^④	0.025	0.01	0.5	29 dc	18 dc	7 dc	1.5 dc
6042H160-2				1	1	10	MS24141-D2	B	100	100	100	100 ^③	—	75 ^④	0.025	0.01	0.5	29 dc	18 dc	7 dc	1.5 dc
6042H166-2				—	1	9	MS24182-D1	D	100	100	100	100 ^③	—	75 ^④	0.02	0.01	0.5	29 dc	18 dc	7 dc	1.5 dc
6042H161-2		3PST	115 Vac	—	2	6	MS24168-D1	B	100	100	100	100 ^③	50 ^⑤	100 ^⑤	0.06	0.015	0.6	29 dc	18 dc	7 dc	1.5 dc
6042H162-2				1	2	8	MS24168-D2	B	100	100	100	100	50 ^⑤	100	0.06	0.025	0.6	29 dc	18 dc	7 dc	1.5 dc
6042H286-2				—	2	8	MS24168-A4	D	100	100	100	100	50 ^⑤	100	0.06	0.11	0.25	120 ac	90 ac	40 ac	10 ac
6042H289-2	1	2	6	MS24168-A3	D	100	100	100	100	50 ^⑤	100	0.06	0.08	0.25	120 ac	90 ac	40 ac	10 ac			
6042H151-2	200	SPST	28 Vdc	—	1	9	MS24142-D1	B	200	100	200	200	—	150	0.035	0.015	0.6	29 dc	18 dc	7 dc	1.5 dc
6042H152-2				—	1	10	MS24142-D2	B	200	100	200	200	—	150	0.035	0.015	0.6	29 dc	18 dc	7 dc	1.5 dc
6042H167-2				1	1	9	MS24183-D1	D	200	100	200	200	—	150	0.03	0.01	0.5	29 dc	18 dc	7 dc	1.5 dc
6042H153-2	300			—	1	9	MS24184-D1	D	300	100	250	300	—	150	0.035	0.015	0.6	29 dc	18 dc	7 dc	1.5 dc
6042H154-2				1	1	10	—	D	300	100	250	300	—	150	0.035	0.015	0.6	29 dc	18 dc	7 dc	1.5 dc
SM400H2-2	400			—	1	9	—	D	400	100	250	400	—	150	0.035	0.015	0.6	29 dc	18 dc	7 dc	1.5 dc
SM400H3-2				1	1	10	—	D	400	100	250	400	—	150	0.035	0.015	0.6	29 dc	18 dc	7 dc	1.5 dc

①Auxiliary switch: SPDT rated 28 Vdc and 115 V 400 Hz, 5 Amp Res. & Ind. & 0.75 Amp Lamp.
 ②Rated 100,000 operations electrical and mechanical life. Auxiliary switch rated 1.25 Amp Res. & 0.75 Amp Ind.
 ③Rated 50 g shock.
 ④These ratings for 115 V 400 Hz only.
 ⑤See MS Sheets for details.
 ⑥Intermittent duty ratings for general applications (see chart below).
 ⑦Ratings for 50/60 Hz only @ 115/200 Vac.



Cat. No. 6042H286
3 PST, 100 Amp



Cat. No. 6042H151
SPST, 200 Amp



Cat. No. 6042H153
SPST, 300 Amp

Characteristics:

- Electrical Life: 50,000 cycles (sea level to 80,000 feet)
- Mechanical Life: 100,000 cycles
- Acceleration: 15 g's
- Shock: 25 g's
- Ambient Temperature Class:
 - B -70°C to 125°C
 - D -70°C to 71°C
- Hermetically sealed/ MIL-PRF-6106

- Twin Break Silver Alloy Main Contacts
- Vibration Levels (Typical):

5-10 CPS .08 DA	10-5 CPS .06 DA	55-200CPS 10 g's
250-500 CPS 5 g's	500-1500 CPS 3 g's	

Intermittent Duty Ratings:

Continuous	15 Minutes	5 Minutes	1 Minute	Max. Inrush
100%	130%	150%	200%	600%

In general, these power relays can withstand the above intermittent duty overcurrent.

Options:

Internal Coil Suppression

Approximate Dimensions and Weights

Catalog Number	Ampere Rating	Dimensions in Inches	Dimensions in Inches						Net Term. Stud Dia. G		Weight	Dimensions in Millimeters						Weight
			Wide	High	Deep	Mounting	Hole	Power	Coil	Lbs.		Wide	High	Deep	Mounting	Hole	Grams	
			A	B	C	D	E			F	A	B	C	D	E	F		
6042H110-2	12	2	3.305	4.485	3.700	3.250	2.687	0.218	.190-32 UNF-2B	.138-32 UNC-2B	1.60	83.95	113.92	93.98	82.55	68.25	5.54	727.27
6042H141-2	25	2	3.305	3.250	3.700	3.250	2.687	0.218	.190-32 UNF-2B	.138-32 UNC-2B	1.50	83.95	82.55	93.98	82.55	68.25	5.54	681.82
6042H142-2	25	2	3.305	4.513	3.700	3.250	2.687	0.218	.190-32 UNF-2B	.138-32 UNC-2B	1.60	83.95	114.63	93.98	82.55	68.25	5.54	727.27
6042H145-2	50	2	3.305	3.200	3.700	3.250	2.687	0.218	.190-32 UNF-2B	.138-32 UNC-2B	1.60	83.95	81.28	93.98	82.55	68.25	5.54	727.27
6042H146-2	50	2	3.305	4.485	3.700	3.250	2.687	0.218	.190-32 UNF-2B	.138-32 UNC-2B	1.70	83.95	113.92	93.98	82.55	68.25	5.54	771.11
6042H147-2	50	2	3.305	3.200	3.700	3.250	2.687	0.218	.190-32 UNF-2B	.138-32 UNC-2B	1.70	83.95	81.28	93.98	82.55	68.25	5.54	771.11
6042H148-2	50	2	3.305	4.485	3.700	3.250	2.687	0.218	.190-32 UNF-2B	.138-32 UNC-2B	1.82	83.95	113.92	93.98	82.55	68.25	5.54	825.54
6042H151-2	200	1	3.640	3.700	3.315	—	3.000	0.266	.375-24 UNF-2B	.138-32 UNC-2B	2.30	92.46	93.98	84.20	—	76.20	6.76	1043.26
6042H152-2	200	1	3.640	4.972	3.315	—	3.000	0.266	.375-24 UNF-2B	.138-32 UNC-2B	2.50	92.46	126.29	84.20	—	76.20	6.76	1133.98
6042H153-2	300	1	3.640	3.700	3.315	—	3.000	0.266	.375-24 UNF-2B	.138-32 UNC-2B	2.40	92.46	93.98	84.20	—	76.20	6.76	1088.62
6042H154-2	300	1	3.640	4.973	3.315	—	3.000	0.266	.375-24 UNF-2B	.138-32 UNC-2B	2.50	92.46	126.31	84.20	—	76.20	6.76	1133.98
6042H155-2	50	1	2.700	2.665	2.835	—	2.188	0.218	.190-32 UNF-2B	.138-32 UNC-2B	0.90	68.58	67.69	72.01	—	55.58	5.54	408.23
6042H156-2	50	1	2.700	3.947	2.835	—	2.188	0.218	.190-32 UNF-2B	.138-32 UNC-2B	1.10	68.58	100.25	72.01	—	55.58	5.54	498.95
6042H159-2	100	1	3.640	3.250	2.925	—	3.000	0.266	.250-28 UNF-2B	.138-32 UNC-2B	1.40	92.46	82.55	74.30	—	76.20	6.76	635.03
6042H160-2	100	1	3.640	4.532	2.925	—	3.000	0.266	.250-28 UNF-2B	.138-32 UNC-2B	1.60	92.46	115.11	74.30	—	76.20	6.76	727.27
6042H161-2	100	2	4.250	4.280	4.220	3.697	3.510	0.218	.250-28 UNF-2B	.138-32 UNC-2B	3.30	107.95	107.57	107.19	93.90	89.15	5.54	1496.86
6042H162-2	100	2	4.250	5.615	4.220	3.697	3.510	0.218	.250-28 UNF-2B	.138-32 UNC-2B	3.45	107.95	142.62	107.19	93.90	89.15	5.54	1568.18
6042H166-2	100	1	3.640	3.063	2.925	—	3.000	0.266	.250-28 UNF-2B	.138-32 UNC-2B	1.10	92.46	77.80	74.30	—	76.20	6.76	498.95
6042H167-2	200	1	3.672	3.282	2.957	—	3.000	0.266	.375-24 UNF-2B	.138-32 UNC-2B	1.70	93.27	83.36	75.11	—	76.20	6.76	771.11
6042H285-2	50	2	3.305	4.485	3.700	3.250	2.687	0.218	.190-32 UNF-2B	.138-32 UNC-2B	1.90	83.95	113.92	93.98	82.55	68.25	5.54	861.83
6042H286-2	100	2	4.235	5.553	4.218	3.697	3.510	0.218	.250-28 UNF-2B	.138-32 UNC-2B	3.70	107.57	141.05	107.14	93.90	89.15	5.54	1678.29
6042H288-2	50	2	3.305	3.200	3.700	3.250	2.687	0.218	.190-32 UNF-2B	.138-32 UNC-2B	1.80	83.95	81.28	93.98	82.55	68.25	5.54	816.47
6042H289-2	100	2	4.235	4.280	4.218	3.697	3.510	0.218	.250-28 UNF-2B	.138-32 UNC-2B	3.60	107.57	108.71	107.14	93.90	89.15	5.54	1636.36
6042H290-2	25	2	3.305	3.250	3.700	3.250	2.687	0.218	.190-32 UNF-2B	.138-32 UNC-2B	1.70	83.95	82.55	93.98	82.55	68.25	5.54	771.11
6042H291-2	25	2	3.305	4.513	3.700	3.250	2.687	0.218	.190-32 UNF-2B	.138-32 UNC-2B	1.90	83.95	114.63	93.98	82.55	68.25	5.54	861.83
SM400H2-2	400	1	3.640	3.700	3.315	—	3.000	0.266	.375-24 UNF-2B	.138-32 UNC-2B	2.40	92.46	93.98	84.20	—	76.20	6.76	1088.62
SM400H3-2	400	1	3.640	4.973	3.315	—	3.000	0.266	.375-24 UNF-2B	.138-32 UNC-2B	2.50	92.46	126.31	84.20	—	76.20	6.76	1133.98

NOTE: All coils and auxiliary terminals are 6-32. Dimensions are approximate and should not be used for construction purposes.

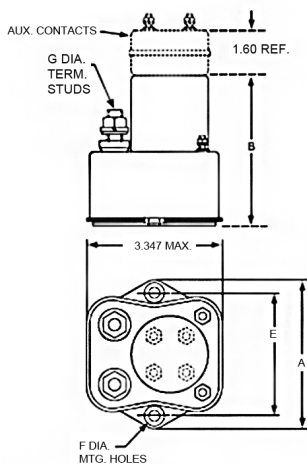

Figure 1

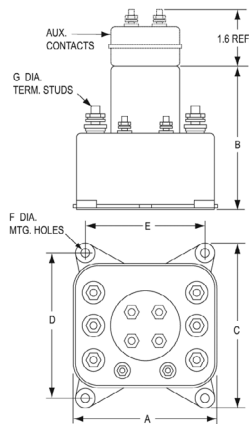
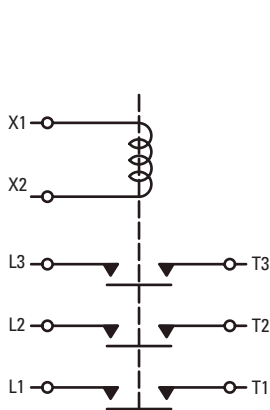
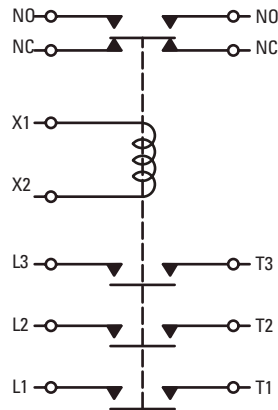

Figure 2

Typical Wiring Diagrams (See Selection Table for Diagram No. Reference)



Dia. No. 1



Dia. No. 2

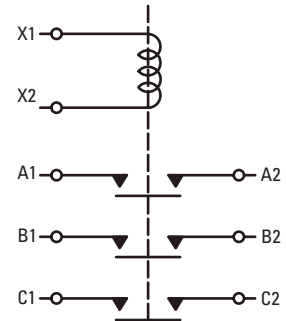

Dia. No. 6

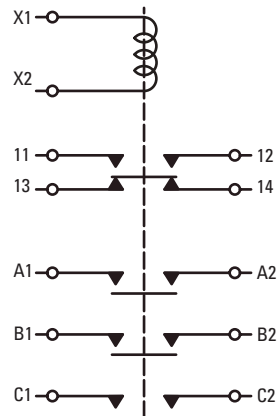

Dia. No. 7

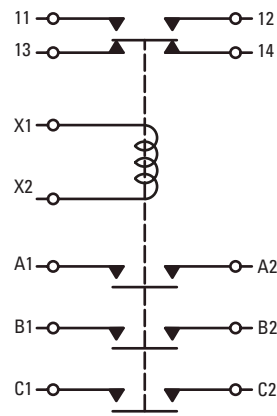

Dia. No. 8

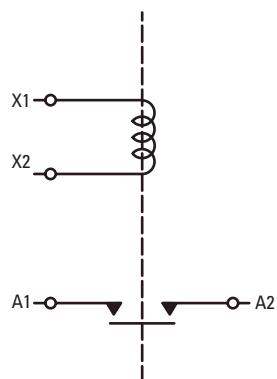

Dia. No. 9

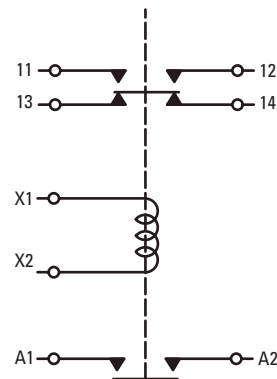

Dia. No. 10