

MINIATURE POSITIVE ACTION SWITCHES

Series - 8855, 8856, 8866-69

MIL-DTL-8834 Miniature Positive Action Switches
Toggle and Lever Lock/IWTS Terminals

FEATURES		SPECIFICATIONS		CURRENT RATINGS								
<ul style="list-style-type: none"> Sealed bushing Dry circuit (logic level loads) to power switching levels 1 and 2 pole circuitry Non-teasible mechanism for all but center "ON" circuit Small and large size bushings and Actuator Toggle and lever lock Actuator Wiping action contacts Positive make and break action Integrated Wire Termination System (IWTS) 	<ul style="list-style-type: none"> Bushing seal or bonded seal per MIL-DTL-8834 MS approved and QPL listed to MIL-DTL-8834 Temperature Range: -67°F to +160°F (-55°C to +71°C) Life: 20,000 operations at rated load 40,000 operations mechanical life Bushing thread sizes: Small Toggle: ¼" - 40 thread Large Toggle and Lever Lock: 15/32" - 32 thread Accepts SAE-AS39029/1-101 Pins (pins not included) 	No. of Poles	Catalog Number	Type of Operation	28VDC (Amperes per pole)		115VAC 60Hz and 400Hz (Amperes per pole)					
					Resistive Load	Inductive Load	Resistive Load		Inductive Load			
							28VDC	28VDC	60Hz	400Hz	60Hz	400Hz
		1	8855 8866 8868	Maintained and Momentary	5	1	2	3	1	2		
		2	8856 8867 8869	Maintained and Momentary	5	1	2	3	1	2		

Minimum Rating: 25 microamperes at 5 millivolts.

SELECTION TABLE

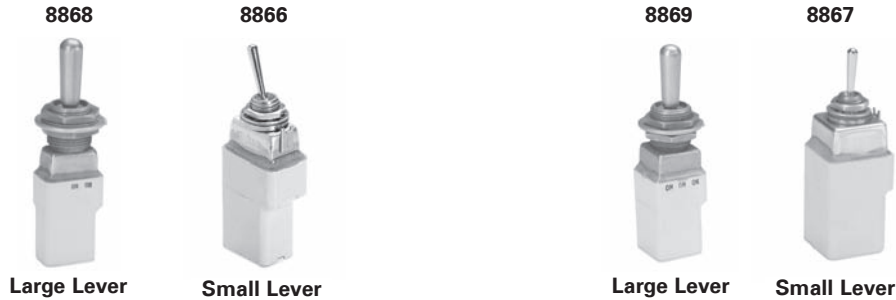

CIRCUIT WITH LEVER IN . . .			ONE POLE				TWO POLE					
Up Position	Center Position	Down Position (Keyway)	MS Part Number	Catalog Number	MS Part Number	Catalog Number	MS Part Number	Catalog Number	MS Part Number	Catalog Number	MS Part Number	Catalog Number
				Large Lever		Small Lever		Large Lever		Small Lever		
ON	OFF	ON	MS21346-211	8868K51	MS24655-211W	8866K51	MS21347-211	8869K51	MS24656-211W	8867K51	MS21347-711	8869K51X
ON	NONE	OFF	-221	K57	-221W	K57	-221	K57	-221W	K57	-721	K57X
ON	NONE	ON	-231	K54	-231W	K54	-231	K54	-231W	K54	-731	K54X
ON	OFF	NONE	-241	K55	-241W	K55	-241	K55	-241W	K55	-741	K55X
ON	OFF	ON	MS21346-271	8868K52	-271W	8866K52	MS21347-271	8869K52	-271W	8867K52	MS21347-771	8869K52X
NONE	OFF	ON*	-281	K56	-281W	K56	-281	K56	-281W	K56	-781	K56X
ON	OFF	ON*	-311	K53	-311W	K53	-311	K53	-311W	K53	-811	K53X
NONE	ON	ON*	MS21346-321	K58 ^①	-321W	K58 ^①	MS21347-321	8869K58 ^①	-321W	8867K58 ^①	MS21347-821	8869K58X ^①
ON	ON	ON	-	-	-331W	-	-331	K59 ^①	-331W	K59 ^①	-831	K59X ^①
ON	ON	ON*	-	-	-351W	-	-351	K510 ^①	-351W	K510 ^①	-851	K510X ^①
ON	ON	ON	-	-	-341W	-	-341	K511 ^①	-341W	K511 ^①	-841	K511X ^①

*** Momentary contact.**

① Dielectric per MIL-DTL-8834 except limited to 1250 volts. Delayed action of the switch toggle lever may cause circuit to close or open before snap action mechanism trips.

② Furnished with Bonded Seal feature. (Meets 15' head of water level requirement.)

SELECTION TABLE



8855



8856

CIRCUIT WITH LEVER IN . . .			ONE POLE		TWO POLE		
Up Position	Center Position	Down Position (Keyway)	Lever Lock Bushing Style	MS Part Number	Catalog Number	MS Part Number	Catalog Number
ON →	← OFF →	← ON	A	MS21346-A211	8855K54	MS21347-A211	8856K54
ON	← OFF →	ON	B	-B211	K55	-B211	K55
ON	← OFF	NONE	B	-B241	K519	-B241	K519
ON	NONE	← OFF	C	-C221	K513	-C221	K513
ON	NONE	← ON	C	-C231	K57	-C231	K57
ON	← OFF	ON	D	MS21346-D211	8855K510	MS21347-D211	8856K510
ON →	NONE	← OFF	E	-E221	K514	-E221	K514
ON →	NONE	← ON	E	-E231	K58	-E231	K58
* ON	← OFF →	ON*	F	-F271	K515	-F271	K515
ON	OFF →	ON*	G	-G311	K516	-G311	K516
* ON	← OFF	ON*	H	MS21346-H271	8855K517	MS21347-H271	8856K517
ON →	← OFF	NONE	J	-J241	K59	-J241	K59
NONE	OFF →	ON*	K	-K281	K518	-K281	K518
ON	← OFF →	ON*	K	-K311	K520	-K311	K520
ON	← OFF	ON*	L	-L311	K512	-L311	L512

*** Momentary contact.**

→ Indicates direction against which lever is locked.
See page A75 for special circuit diagrams.

OPTIONS/ACCESSORIES LEVER LOCK - BUSHING STYLES

- Special mounting hardware
- Special marking
- Mounting hardware furnished assembled
- Panel seal, Part Number 32-341 (15/32" - 32 bushing only)
- Special circuits
- Special bushing and lever finish
- Special locking cap style on lever lock switches
- EMI/RFI capability on two pole (15/32" - 32 bushing only)

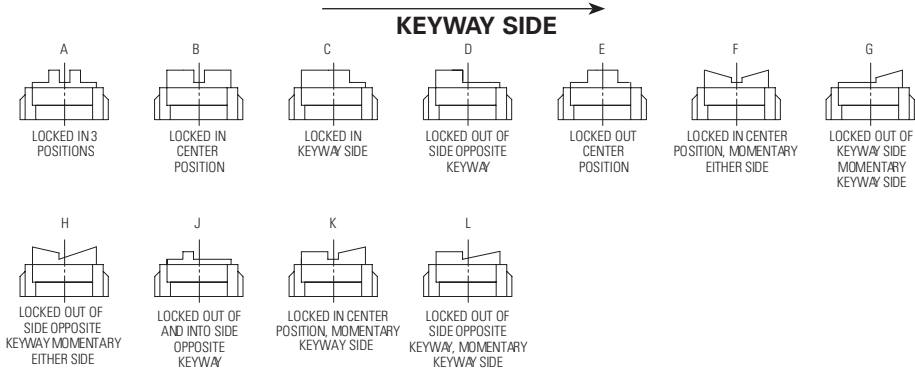

Figures A thru L do not represent details of construction. They schematically illustrate locking function.

PANEL CUTOUT DIMENSIONS

15/32 DIA. BUSHING

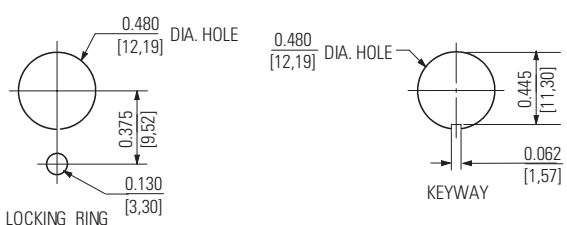

1/4 DIA. BUSHING

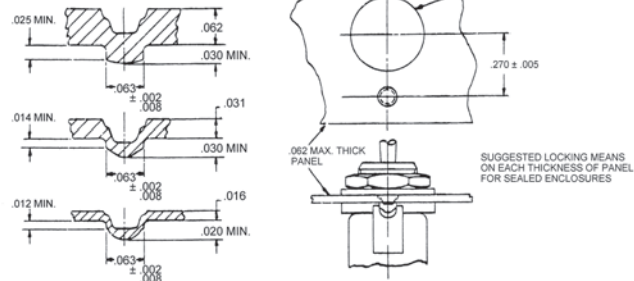

"Safran Electrical & Power Proprietary Information. Information contained in this document is Safran Electrical & Power Proprietary Information and is disclosed in confidence. It is the property of Safran Electrical & Power and shall not be used, disclosed to others, or reproduced without the express written agreement of Safran Electrical & Power. If consent is given for reproduction in whole or in part, this notice set forth on each page of this document shall appear in any such reproduction in whole or in part. Unauthorized export or re-export is prohibited."

MINIATURE POSITIVE ACTION SWITCHES

Series - 8855, 8856, 8866-69

MIL-DTL-8834 Miniature Positive Action Switches
Toggle and Lever Lock/IWTS Terminals

MOUNTING DIMENSIONS - ONE POLE / 8855, 8866, 8868



Small Toggle



Large Toggle/ Terminal Identification



Lever Lock

MOUNTING DIMENSIONS - TWO POLE / 8856, 8867, 8869

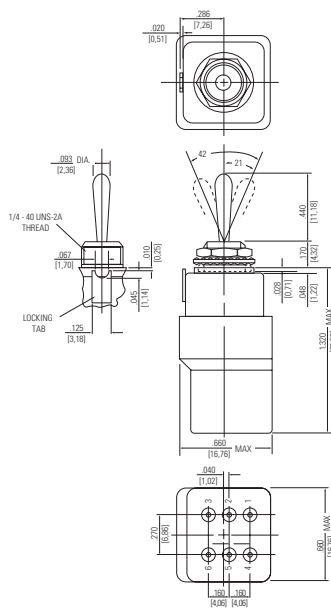

Small Toggle

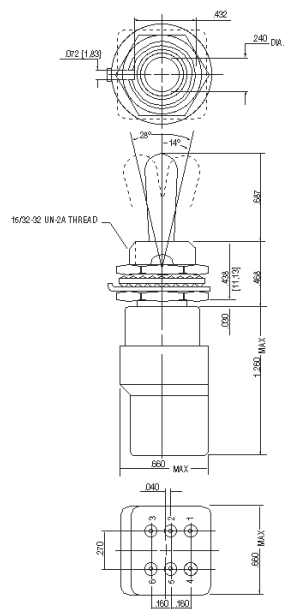

Large Toggle/ Terminal Identification

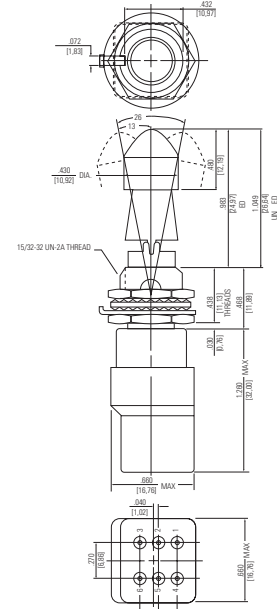

Lever Lock

STANDARD
0.00 = inches
[0,0] = mm

Mounting dimensions for reference only.