

SAFRAN ELECTRONICS & DEFENSE AVIONICS USA LLC



800 & 820 SERIES



Series 800 & 820 features

The SAFRAN Series 800 & 820 are rack mounted, plug-in type, 4-lamp lighted pushbutton switch or indicator light assemblies with display face for up to four lines of legend. Both series meet the requirements of MIL-S-22885 and offer a completely modular approach to developing modern, human-engineered, lighted-switch/indicator panel layouts for commercial, industrial, military, and aerospace applications.

The Series 800 offers a 3/4 inch square display face and the Series 820 offers a 3/4 inch high by one inch wide display face. All other features of both the switch-lite and indicator-lite units in each series are identical. The versatility afforded by their small size, close center-to-center spacing, 4-lamp illumination, and plug-in connectors make them ideal for almost any requirement from a single-unit mounting all the way up to multi-matrix configurations. You can procure a complete system, tailored to your needs, and ready to wire with crimp-type insertable terminals.

The switch-lite units are available with alternate or momentary action in 2PDT or 4PDT. A choice of holding coils (momentary action) is available to provide electrical interlock. The front lens is available as a full display or as a split display for more than one message indication. Each of the four lamps may be individually controlled to provide selected illumination and the use of different colors.

Each switch-lite or indicator-lite unit plugs into a prewired terminal block in the back of each channel in the mounting rack. The mounting rack itself is a modular assembly that can be made to accommodate anything from a single unit to multiple unit matrices. Each rack assembly mounts through a single panel cutout for a simple and economical installation.

How to use this catalog

800 series No	A1C1E2	J3	L2	M1	N2	(RG)	16	ON/OFF
(800 or 820) Pages 4 & 5	Basic Unit Type Pages 6 & 7	Lamp Type Page 8	Lens Type Page 9	RFI Screen (Optional) Page 9	Display Screen Arrangement Page 9	Color Filter Page 9	Legend Configuration Page 10	Legend Wording Page 10

The pages of this catalog describe each element of the Series 800 or 820 switch-lite or indicator-lite units and mounting rack assemblies. To determine the units you need, simply select the codes that define your choice of each element. The selected codes, written together (without dashes; dashes are only shown in examples for clarity), become the part number you will use for ordering. A sample of a typical part number is shown on the left with callouts identifying what each of the codes mean.

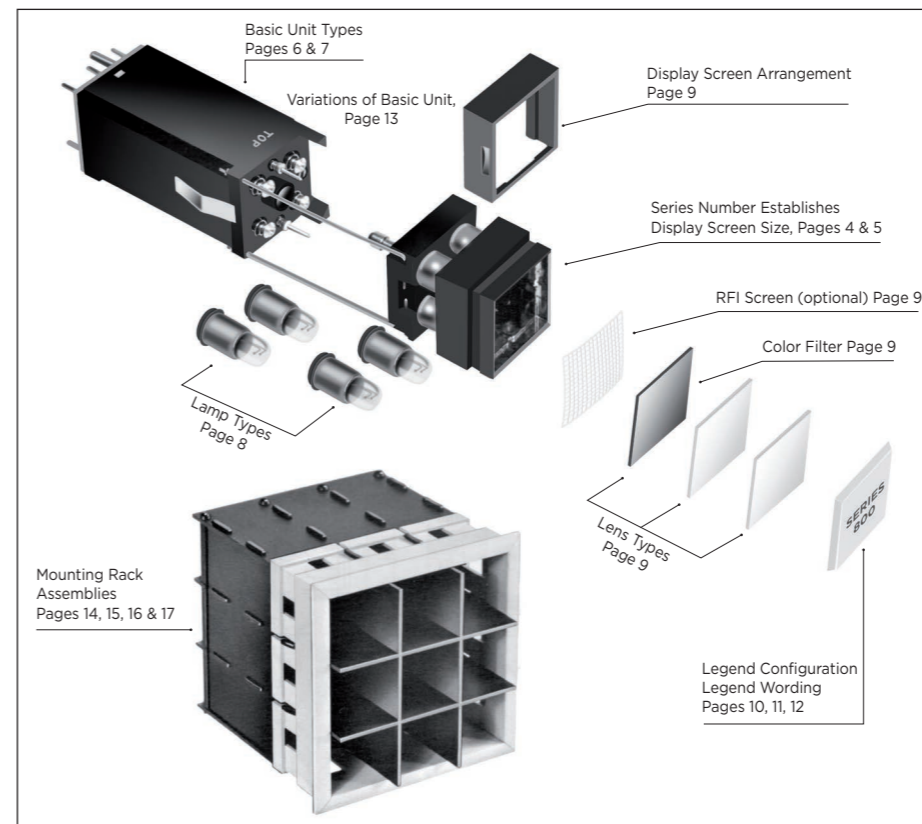

A sample part number appears at the top of each page describing the code you are selecting from that page.

The illustrations aside identify the elements you can specify and the pages of the catalog that describes each element. An alternate simplified ordering method is available; wherein items required for a complete switch-lite, or indicator-lite unit, or even an assembly of units in a mounting rack are defined in a Specification Sheet maintained for the specific customer by Safran. Consult your Safran representative for details.

SERIES NUMBER

800A1C1E2J3L2M1N2(RG)16 ON/OFF

SERIES 800

The Series Number, for this particular product line, establishes the display screen size. The Series 800 provides a 3/4 inch square display screen face. All other elements of the unit are identical to the Series 820, which provides a 3/4 inch high by one inch wide display screen face. Both units are available as either a switch-lite or indicator-lite. The drawings below show the overall outline dimensions for the Series 800.



820A1C1E2J3L2M1N2(RG)16 ON/OFF

SERIES 820

The Series Number, for this particular product line, establishes the display screen size. The Series 820 provides a 3/4 inch high by one inch wide display screen face. All other elements of the unit are identical to the Series 800, which provides a 3/4 inch square display screen face. Both units are available as either a switch-lite or indicator-lite. Although the sample codes at the top of the following pages reference the Series 800, all elements are also applicable to the Series 820. The drawings below show the overall outline dimensions for the Series 820.

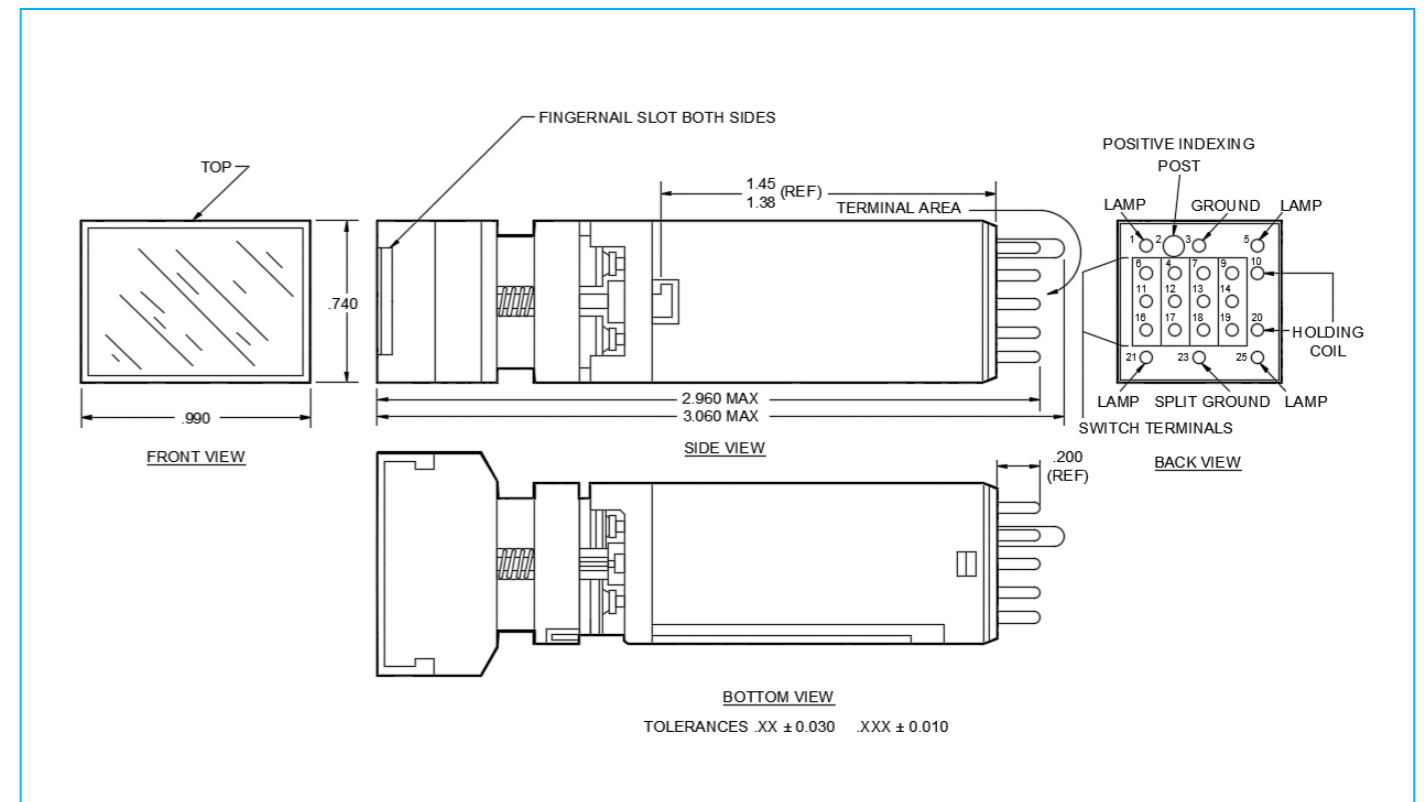
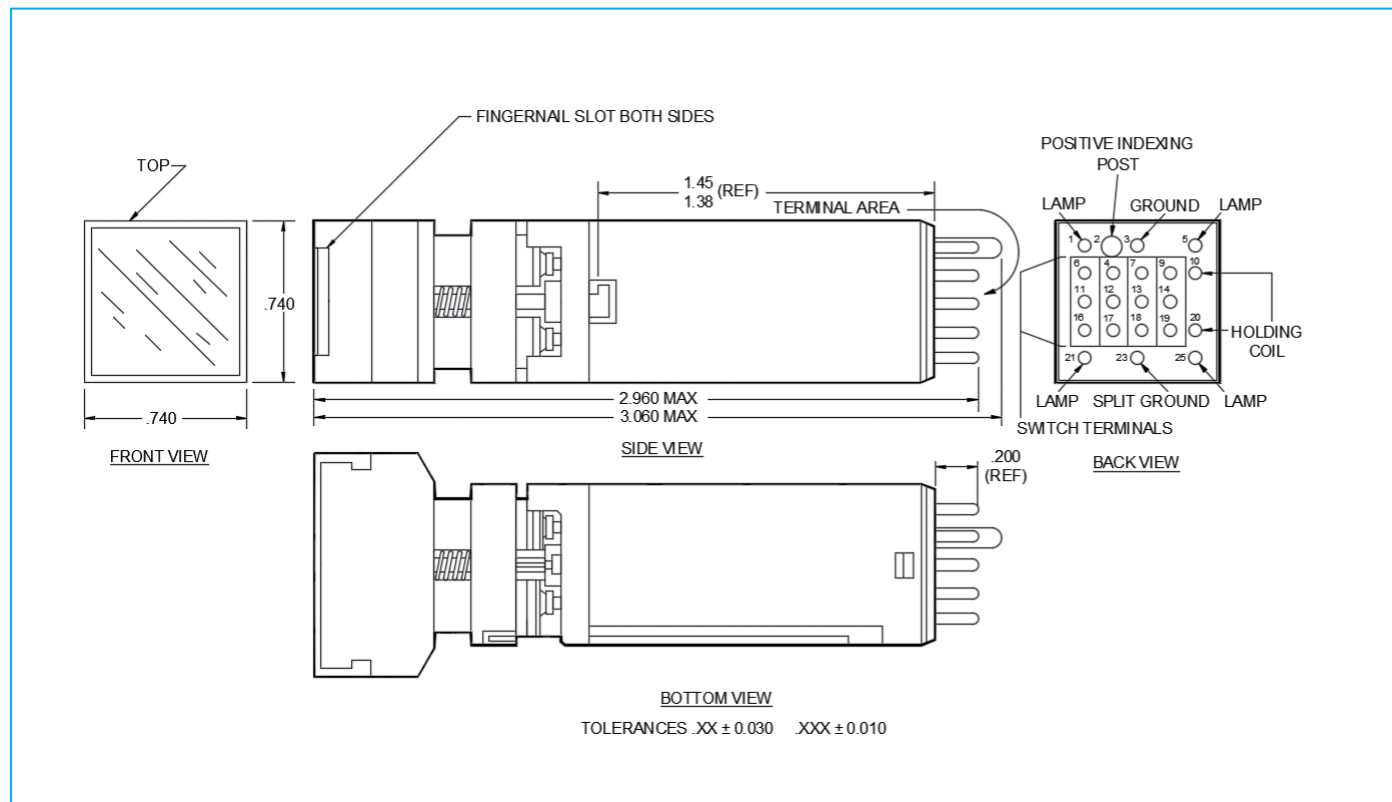



BASIC SWITCH-LITE OR INDICATOR-LITE

800A1C1E2J3L2M1N2(RG)16 ON/OFF

FOUR TYPES AVAILABLE

Series 800 I 820 is available in four types of basic units with either an integral switch or without any switch mechanism as an indicator only. Each type of basic unit is described below:

SWITCH-LITE (MOMENTARY ACTION/2PDT OR 4PDT)

Combines capability of both indication and switching. Depressing front lens transfers switch contacts so long as the front lens is held down. Removing actuating force returns switch contacts to their normal position and front lens returns to its retracted position. Switch contacts are completely isolated from the lamp circuit, allowing independent control of illumination.

SWITCH-LITE (ALTERNATE ACTION/2PDT OR 4PDT)

Combines capability of both indication and switching. Depressing front lens transfers switch contacts, and they remain transferred even after the actuating force is removed and the front lens has returned to its retracted position. Depressing the front lens again returns the switch contacts to their normal position. Switch contacts are completely isolated from the lamp circuit, allowing independent control of illumination.

SWITCH-LITE WITH HOLDING COIL (MOMENTARY/2PDT OR 4PDT)

Numerous electrical interlock, lock-in and lock-out circuits are made possible with the inclusion of a magnetic, holding coil to the momentary action switch-lite. Prior to energizing the holding coil, the operation is the same as a momentary action switch-lite. Once holding coil is energized, it will hold the contacts in their actuated position. Removing power from the holding coil will cause the contacts to return to their normal position. Available in 6, 12, 28, or 48 V.D.C.

INDICATOR-LITE ONLY

The basic unit may be ordered without a switch mechanism for applications requiring indication only.

FULLY IDENTIFIED TERMINALS

All terminals are clearly marked by number. Terminals 1, 5, 21, and 25 in each of the four corners are for each of the four lamps. Terminal 3 is a common lamp ground. Switch terminals provide capacity for up to 4PDT. All switch terminals are grouped within a rectangular marked area on the terminal block. 2PDT switching utilizes terminals 7, 12, 17, and 8, 13, and 18. Each terminal is marked for normally open, normally closed, and common.

POSITIVE INDEXING ASSURES PROPER ORIENTATION

A large post on the terminal end of the switch-lite unit mates with a hole in the connector block at the rear of each channel in the mounting rack. Since the post is too large to fit the standard terminal holes, the switch-lite can only be plugged in when properly oriented.

EASILY LOCKS INTO MOUNTING RACK ASSEMBLY

After the unit has been plugged into the mounting rack, simply pull the display screen/ lamp capsule out and to one side. Then, rotate the small screw on the face of the switch housing. It will turn a locking arm which mates with a slot in the mounting channel, thus locking the switch-lite unit firmly in place.



TYPE OF BASIC UNIT (Switch action & number of poles)	PART NUMBER CODE BY LAMP CIRCUIT		
	Common Grd. 1 3 5 21 25 (Most commonly used) Lamp Circuit 1	Horizontal Split Grd. 1 3 5 21 25 23 G Lamp Circuit 2	Vertical Split Grd. 1 3 5 21 25 23 G Lamp Circuit 3
INDICATOR-LITE	A2C1	A2C2	A2C3
SWITCH-LITE			
2PDT ALTERNATE	A1C1D2	A1C2D2	A1C3D2
4PDT ALTERNATE	A1C1D4	A1C2D4	A1C3D4
2PDT MOMENTARY	A1C1E2	A1C2E2	A1C3E2
4PDT MOMENTARY	A1C1E4	A1C2E4	A1C3E4
SWITCH-LITE WITH HOLDING COIL (MOMENTARY)			
6 volt	2 PDT A4C1E2	A4C2E2	A4C3E2
	4 PDT A4C1E4	A4C2E4	A4C3E4
12 volt	2 PDT A5C1E2	A5C2E2	A5C3E2
	4 PDT A5C1E4	A5C2E4	A5C3E4
28 volt	2 PDT A3C1E2	A3C2E2	A3C3E2
	4 PDT A3C1E4	A3C2E4	A3C3E4
48 volt	2 PDT A6C1E2	A6C2E2	A6C3E2
	4 PDT A6C1E4	A6C2E4	A6C3E4
SWITCH-LITE WITH HOLDING COIL (MOMENTARY) Has 1N645 suppression diode across pins 10 & 20			
6 volt	2 PDT A8C1E2	A8C2E2	A8C3E2
	4 PDT A8C1E4	A8C2E4	A8C3E4
12 volt	2 PDT A9C1E2	A9C2E2	A9C3E2
	4 PDT A9C1E4	A9C2E4	A9C3E4
28 volt	2 PDT A10C1E2	A10C2E2	A10C3E2
	4PDT A10C1E4	A10C2E4	A10C3E4
48 volt	2 PDT A11C1E2	A11C2E2	A11C3E2
	4 PDT A11C1E4	A11C2E4	A11C3E4
SWITCH-LITE WITH LOW ACTUATION FORCE (MOMENTARY) Includes Moisture-Proof			
	1 PDT A1C1D2	A1C2E1	A1C3E1
	2 PDT A1C1D4	A1C2E2	A1C3E2
	3 PDT A1C1E2	A1C2E3	A1C3E3
	4 PDT A1C1E4	A1C2E4	A1C3E4



SPECIFICATIONS

SWITCH SPECIFICATIONS:

Switch Action: Snap action
 Actuation Force: 4.0 lbs. maximum
 Actuation Travel: 3/16" Nominal
 Switch Contacts: Gold plated silver
 Total Transfer Time (including Bounce): 2 millise., max.
 Simultaneity: All contacts transfer within 3 millise.
 Mechanical Life: 100,000 cycles
 Electrical Life: 50,000 cycles

ELECTRICAL SPECIFICATIONS:

Resistive Load: 5 Amps @ 115 VAC/28 VDC*
 Inductive Load: 2.5 Amps @ 115 VAC/28 VDC*
 Lamp Load: 1.5 Amps @ 115 VAC/28 VDC
 Low-Current Switching Capability : 10 mA @ 1 VDC
 (@ room temperature)
 Switch Contact Resistance: 25 milliohms, max.
 (per MIL-S-22885)
 Lamp Contact Resistance: 1 Ohm, max. (per MIL-S-22885)
 Holding Coil: Nominal Voltage: 6 VDC, 12 VDC, 28 VDC
 and 48 VDC.
 Minimum «hold-in» voltage is 50% of nominal rating.
 Dielectric Withstanding Voltage: 1,000 V RMS
 (per MILS-22885)
 Insulation Resistance: 1,000 megohms, min. (per MILS-22885)

ENVIRONMENTAL SPECIFICATIONS:

Vibration: 10 G's to 500Hz (per MIL-STD-202, Method 204, Cond. A)
 Shock: 75 G's (per MIL-STD-202, Method 213, Cond. B)
 Operating Temperature Range: - 55°C to + 71° C
 (per MIL-S-22885)
 Salt Spray: 96 Hrs. (per MIL-STD-202, Method 101, Cond. A)
 Moisture Resistance: 10 days (per MIL-STD-202, Method 106)
 Explosion: (per MIL-STD-2020, Method 109A)

*With electrical life at 25,000 cycles, the switch is rated for 7.0 Amps-resistive loads, and 4.0 Amps-Inductive loads.

LAMP TYPES

800A1C1E2J3L2M1N2(RG)16 ON/OFF

EASY LAMP REPLACEMENT FROM PANEL FRONT WITHOUT TOOLS

Replace lamps quickly without having to remove the unit from its mounting. Slots on the sides of the display housing allow lamp-carrier assembly to be easily pulled out and swung to the side, exposing the back of the housing for complete access to the lamps. This is accomplished from the panel front without the use of any tools.

ATTACHED LAMP CAPSULES PREVENT TRANSPOSITION

The display screen/lamp-capsule assembly is permanently connected to the basic unit by two stainless steel wires. This prevents the capsule from being accidentally transposed into an adjacent switch unit when relamping or replacing legend lenses and color filters.

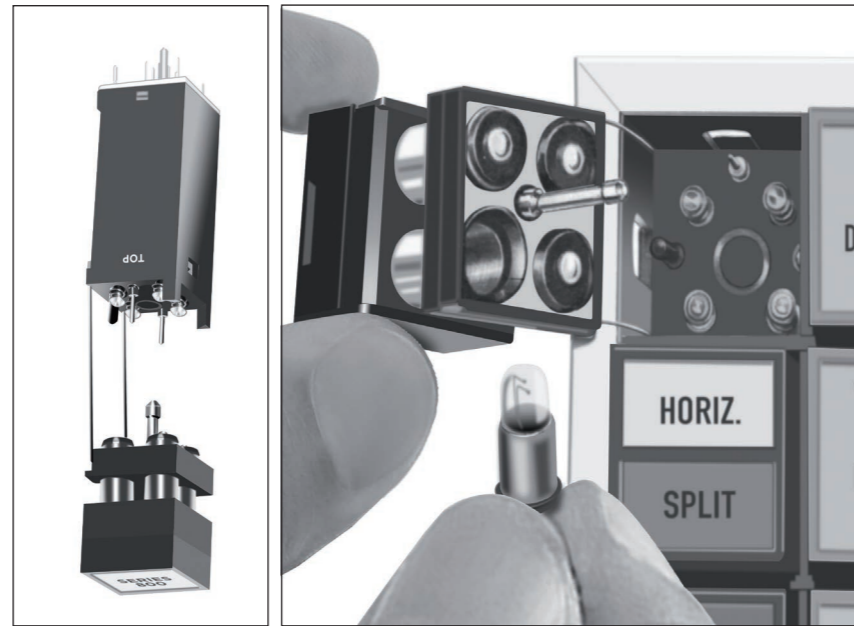

LAMPS REMAIN STATIONARY; AVOID SHOCK; LAST LONGER

When the switch-lite display face is depressed during switch actuation, it travels back over the lamp barrels, so that the lamps remain stationary at all times.

This feature helps to extend lamp life by eliminating any shock the lamps might otherwise receive during switch actuation.

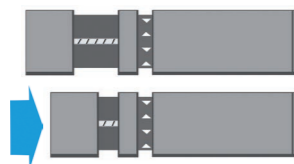

INCANDESCENT TYPE LAMPS

PART NUMBER CODE FOR TYPE OF LAMP				
6 Volt Lamps	12 Volt Lamps	28 Volt Lamps	115 V.A.C. neon Lamps with Resistor	115 V.A.C. neon Lamps without Resistor*
J1	J2	J3	J4	J10

*Recommended for use with red or amber colors only.

LAMP TYPES

T-1 3/4 midget flange base incandescent lamps are available in 6, 12, and 28 volts. A special neon lamp with or without a built-in current limiting resistor is also available for 115 V.A.C. applications, but it is only recommended for use with red or amber colors. See the accompanying table for part number ordering codes. Note: neon lamps without a built-in resistor require external current limiting resistance.

L.E.D TYPE LAMPS

PART NUMBER CODE FOR TYPE OF LAMP					
5 Volt	6 Volt	12 Volt	15 Volt	24 Volt	28 Volt
J70(*)	J71(*)	J72(*)	J73(*)	J74(*)	J75(*)

*Red, Green, or Yellow

DISPLAY SCREEN

800A1C1E2J3L2M1N2(RG)16 ON/OFF

EASY LEGEND/COLOR FILTER REPLACEMENT FROM PANEL FRONT WITHOUT TOOLS

You can replace legend/color filters easily from the panel-front without tools allowing easy cleaning and/or changes. After pulling out the display screen lamp capsule assembly, a simple upward sliding motion frees the lens retainer housing, permitting the removal of the lens and filters.

LENS TYPES

There are four types of lenses available, each producing a different type of legend display, as described below. The numbers preceding each lens type are the part number codes.

L1-LENS TYPE 1-LIGHTED LETTERS:

Letters appear white on a black background until illuminated and then letters appear in color, background remains black.

*L2-LENS TYPE 2-LIGHTED BACKGROUND:

Letters appear black on a white background until illuminated and then background appears in color, letters remain black.

L3-LENS TYPE 3-LIGHTED LETTERS:

Letters are not legible until illuminated and then letters appear in color, background is black.

L4-LENS TYPE 4-LIGHTED BACKGROUND:

Letters are not legible until illuminated then background appears in color, letters are black.

*This is the most commonly used and preferred type of lens for most applications.



RFI SCREEN

An RFI Screen may be specified by using the code «MI». This is an optional item and should only be specified in applications where radio frequency interference is a problem. The screen will minimize RFI entrance through panel cutout.

DISPLAY SCREEN/COLOR FILTER ARRANGEMENT

Select the number above the illustrations below that describes the display screen arrangement you desire. Use the letters in brackets below the illustrations to indicate the required color filters. The sequence in which the letters for the color filters must be written in the brackets is in order of viewing from upper left, upper right, lower left, lower right, as shown in the diagrams.

N1	N2	N3	N11	N12	N13	N14	N15
R	R	R	A	Y	A	G	R
(R)	(RG)	(RG)	(AGR)	(YGR)	(ARB)	(GYB)	(RABG)

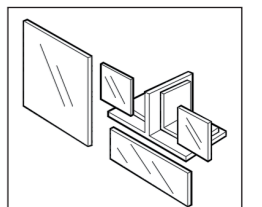

The letter codes for colors are: (A) mber (B) lue (R) ed (W) hite (Y) ellow
NOTE: WHITE is produced by a light blue colored filter

TWO-COLOR FULL DISPLAY

Colored silicone bulb-boots that are mounted over the lamps may be specified for use when two colors are required for a full-display (N1). This makes it possible to project one color over the full display for one condition and then a second color over the full-display for a different condition.

To order a basic unit for two-color full-display, replace the «A» in the basic unit code, shown on page 7, with «B»; e.g. 800-B1C1E.

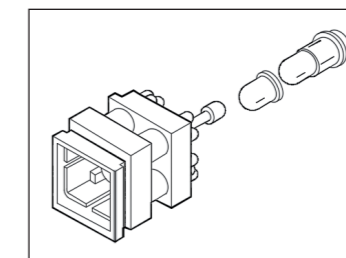

To order the bulb-boots for the two color display, place a «T1» between the «N1» code and the color designation in the display screen code; e.g. L1-N1-T1 (RG). Bulb-boot color codes are same as shown above for lenses.

LEGENDS

800A1C1E2J3L2M1N2(RG)16 ON/OFF



The part number code for the legend should always follow the Display Screen Arrangement code, since it indicates the legend configuration and the actual legend wording, which goes on the lens. The legend is ordered by using the legend configuration number and following it with the actual wording, using commas between rows of letters and a diagonal slash line between splits.

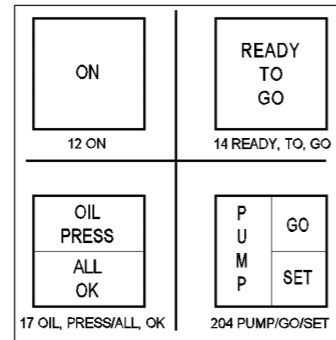

Priority for legend wording for segments of split displays, when viewed from the panel front is upper left, upper right, lower left, lower right. Examples of legend ordering are shown below.

Note: Display screen will accept up to four rows of .093" high letters.

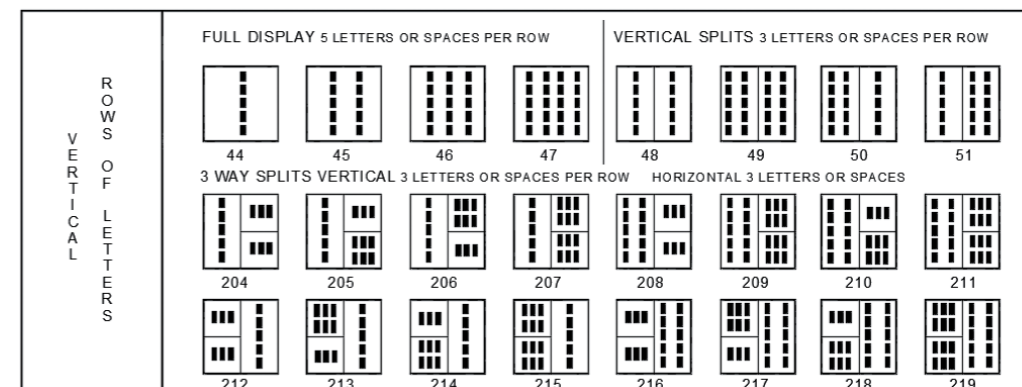
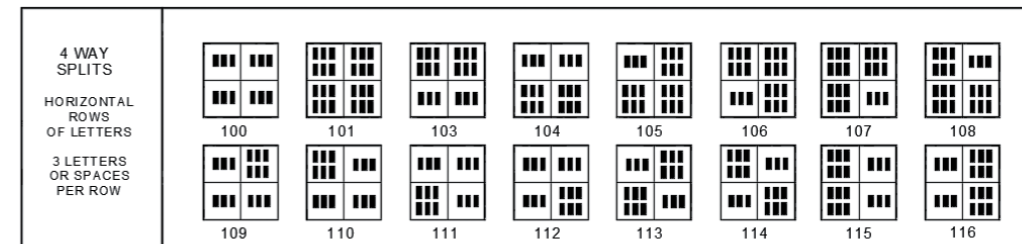
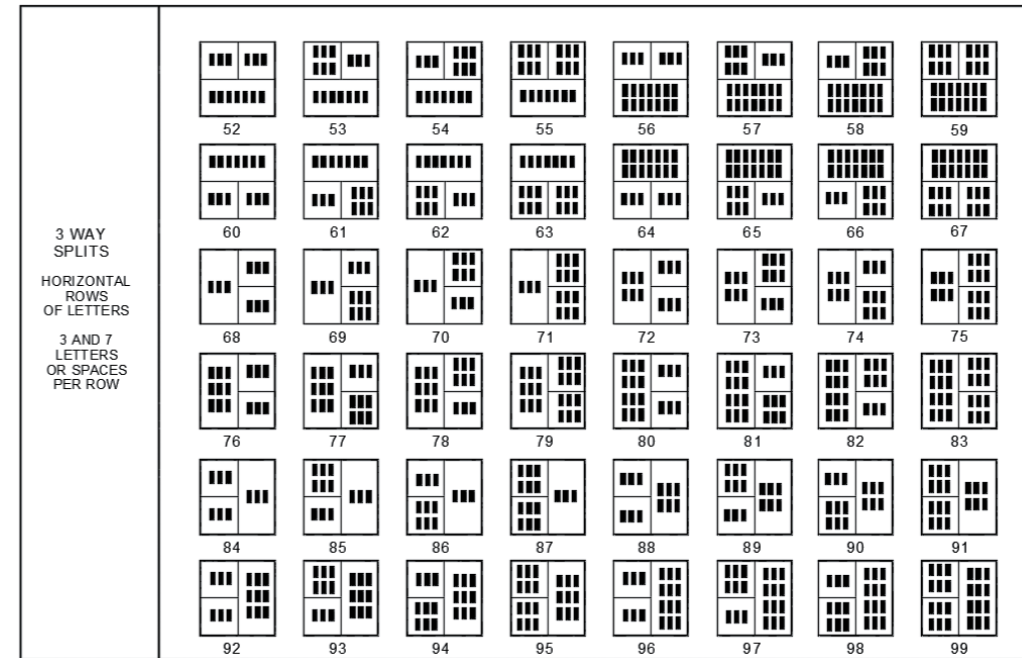
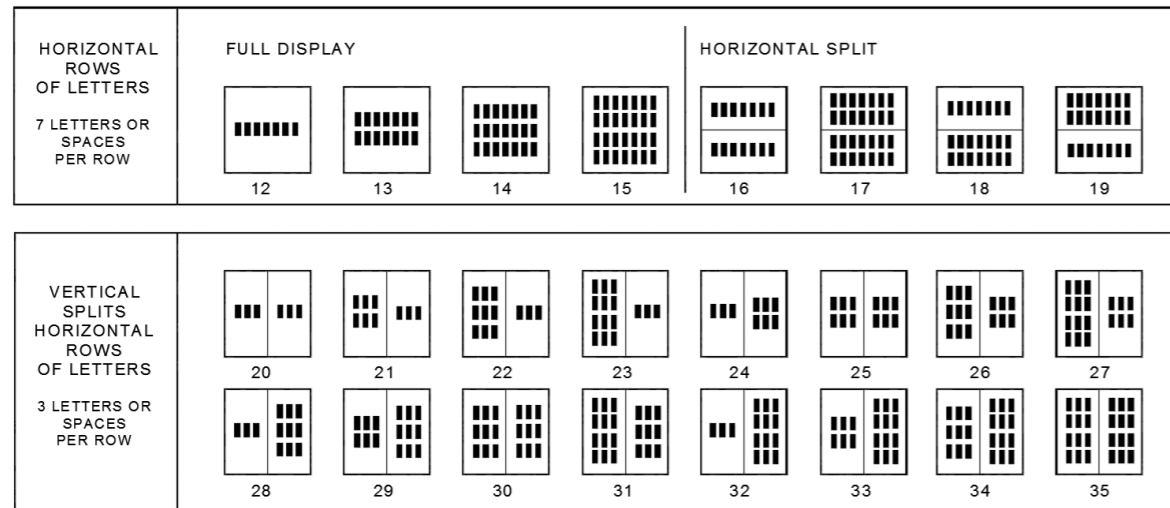

LEGENDS

NOTE: For Series 820 the same code numbers for legends apply, however, you can use more letters and spaces across the display face due to the wider width of the display face.

The following number of letters and spaces can be used for the Series 820:

HORIZONTAL ROWS OF LETTERS

Full Display & Horizontal Split Display: 10 letters or spaces per row

Vertical Split Display: 4 letters or spaces per row

3-Way Splits:

- 4 letters or spaces in segments using 1/2 screen width
- 10 letters or spaces in segments using full screen width

4-Way Splits:

- 4 letters or spaces per row

VERTICAL ROWS OF LETTERS

Full Display & Vertical Split Display; 5 letters or spaces per row vertically

3-Way Splits:

- 5 letters or spaces per row vertically;
- 4 letters or spaces per row horizontally.

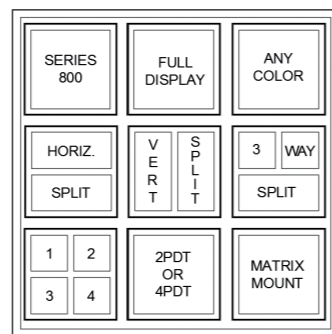

VARIATIONS OF BASIC UNIT

800 A1C1E2J3L2M1N2(RG)16 ON/OFF

The following are descriptions of variations of the basic unit that offer particular capabilities for special requirements.

Code numbers for most of these items are to be written into the part number following the Series Number and preceding the Basic Unit Code.

LOW ACTUATION FORCE (A12)

The standard actuation force for Series 800 and Series 820 switch-lite units is 4.0 lbs. maximum. Units may also be ordered with a low force actuation of less than 16 oz.

This is ideal for keyboard type arrangements or other applications where light-pressure actuation is desired.

To order low force actuation units, change the «A1» in the basic unit code to «A12», e.g. A12C1E2.

Note: these units are standard with moisture-proof requirement, as described below, but are not available with high-shock requirement or as alternate action or holding coil units.

MOISTURE PROOF REQUIREMENT (10)

The Series 800 and Series 820 units can be modified to meet the special moisture-proof requirements of MIL-S-22885C Paragraph 4.8.17.2, seal (drip-proof); and MIL-STD-108E, Paragraph 4.3, seal (drip-proof).

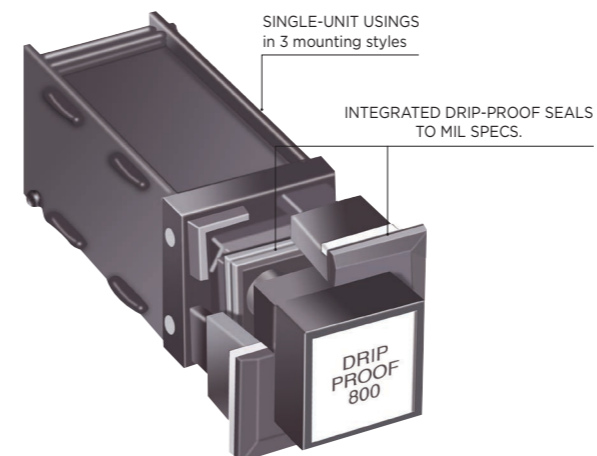

To order units with this capability, insert the number «10» as the part number code between the Series Number and the Basic Unit Number. e.g. 800-10-A1C1E2 ... (without dashes; dashes only used in example for clarity.) These units must be used with appropriate moisture-proof mounting racks (see page 15).

HIGH-SHOCK & MOISTURE-PROOF (8)

The Series 800 and Series 820 units can be modified to meet both the special high-shock and moisture-proof requirements detailed above.

To order units with both of these capabilities, insert the number «8» as the part number code between the Series Number and the Basic Unit Number, e.g. 800-8-A1C1E2 ... (Without dashes; dashes only used in example for clarity.) These units must be used with the appropriate high-shock and moisture-proof mounting racks (see page 15).

Note: These units are not available as alternate action, holding coil, or low-force actuation units.

DUMMY UNITS

Dummy units are available to fill empty mounting rack channels reserved for future use. The part number for the standard black dummy unit is **800-G**.

SWITCH GUARD

A special switch-guard accessory is available to protect the face of switch-lite units against accidental actuation.

To order the switch guard accessory, use the part number **800-508**.

This accessory is only available on switch-lite units used in single-unit mounting cans 800-R1 and 800-R2 (see page 15). Other switch-guard accessories for use with the aluminum mounting rack assembly are available upon special request to the factory.

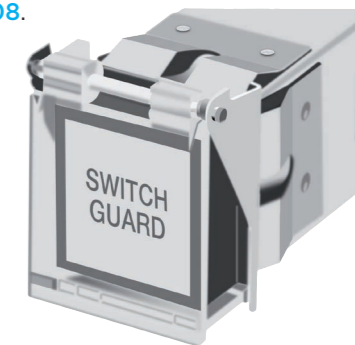



PRE-ASSEMBLED, MODULAR ALUMINIUM MOUNTING RACKS

The mounting rack and terminal block assembly is a modular unit that can have any number of desired channels in to which the switch-lite or indicator-lite assemblies are inserted for plug-in installation. Maximum square matrix is 12 x 12; maximum rectangular matrix is 5 x 20. Mounted in the panel through a single panel cutout, this assembly provides significant advances in mounting style, wiring, maintainability and building block capability. Complete mounting hardware is supplied with each assembly. The customer can purchase the mounting rack in advance of the switch-lite units to expedite the panel installation and inter-wiring of assemblies. These racks are available with moisture-proof and high-shock requirements. This type of rack is available for both Series 800 and 820 units.

READY TO WIRE WITH CRIMP-TYPE INSERTABLE TERMINALS

Crimp-type, solderless, insertable terminals are used to wire the terminal blocks located at the rear of each channel in the mounting rack. This type of terminal is crimped onto the end of each wire using a M22520/1-01 crimping tool with M22520/1-02 head or a standard MS3191 crimp tool and the Safran locator, that fits in this tool.

Three type of terminals are available that will accommodate AWG stranded wire, sizes# 18 thru #28. The terminals are then inserted into the proper holes in the terminal block and held firmly in place by integral locking tabs.

CHANNEL DIVIDERS FORM BARRIERS TO PREVENT INADVERTENT ACTUATION

Dividers in the mounting rack extend out slightly beyond the face of the mounting rack itself to form a natural barrier between units. To actuate a particular switch -lite, the display face must be depressed below the level of the barrier. If two adjacent units are accidentally depressed simultaneously with one finger, the barrier will prevent actuation.

POSITIVE MOUNTING TO PANEL; NO SCREW HOLES REQUIRED

Once the mounting rack has been inserted through the panel cutout from the front, mounting fasteners

are slipped into slots on the rack frame and tightened against the back of the panel to secure the entire rack assembly to the panel. This provides a simple, economical installation that leaves no mounting hardware visible from the panel front. As many fasteners desired may be used on the frame, with up to one per channel around the perimeter of the rack, depending on the requirements of the application.

M22520 CRIMP TOOL OR MS3191

To crimp the terminals onto the end of each wire, either of two types of crimp tools can be ordered. One type of crimp tool is the 800-22520/i-01 with 800-22-520/i-02 turret head. The other is the standard MS3191 crimp tool, which can be ordered using part number 800-3191. To use the MS3191 crimp tool, you will need a terminal locator.

To order the applicable Safran terminal locator, use the following part numbers: **800-3191-L20** for terminals **800-CT20** or **800-CT20-3** and **800-3191-L20-2** for terminals **800-CT20-2**.

CRIMP-TYPE TERMINAL PACKET

Specially fabricated crimp-type terminals, which lock into place in the terminal blocks by the use of a unique built-in spring-action, are required and must be ordered separately. They come in packages of quantity 25. Terminal packets can be shipped prior to the mounting racks to facilitate advance attachment to wires. To order terminal sockets use the applicable part number. **800-CT20** accepts one #20, #22, or #24 gauge wires. **800-CT20-2** accepts one #26 or #28 gauge wire. **800-CT20-3** accepts one #16, one #18, 2 #20 or 2 #22 gauge wires. Safran removal tool - part number **800-P-2**.



800-R0803-1 / 820-R0803-1

800	R	H	W	08	03	1
Series No.	Indicates Aluminum Rack with Terminal Blocks	Includes High-Shock Requirement	Includes Moisture Proof Requirement	Number of Units in the Horizontal Axis	Number of Units in the Vertical Axis	Bezel Finish

Mounting racks are ordered separately from the switch-lite or indicator-lite units. To order, specify 800-R followed by two digits to identify the number of units in the horizontal axis and then two more digits for the number of units in the vertical axis. Finally a dash number, which gives the bezel finish desired, is added at the end. Special capabilities for high-shock and moisture-proof may be added to the rack by adding the appropriate code designation after the «R» and before the two digits indicating the horizontal number of units. A typical part number is illustrated at the left, including these special capabilities.

HIGH-SHOCK REQUIREMENTS (H)

This type of mounting rack can be modified to meet the special high-shock requirements of MIL-S-22885 C, Method II, Paragraph 4.813.2/3.6.13.2; MIL-STD-2020, Method 207A; and MIL-S-901C, Amendment 1, Grade A, deck mounted sub-assembly, Class I, lightweight, Type C.

To order racks with this capability, insert the letter «H» after the «R» and before the two digits indicating the horizontal number of units, e.g. **800-RH0803-1**.

Maximum size matrix is 2 x 10 or 10 x 2.

MOISTURE-PROOF (W)

This type of mounting rack can be modified for use with Series 800 or 820 switch-lite or indicator-lite units that meet the special moisture-proof requirements of MIL-S-22885C, Paragraph 4.8.17.2, seal (drip-proof); and MIL-STD-108E, Paragraph 4.3, seal (drip-proof).

To order racks with this capability, insert the letter «W» after the «R» and before the two digits indicating the horizontal number of units, e.g. **800-RW0803-1**.

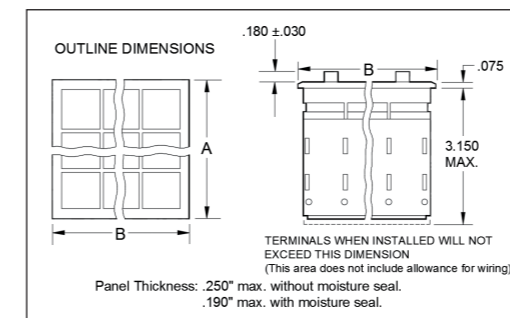

CAUTION

Before installing units into housing, a light coating of dow corning FS 3451 lubricant, or equivalent, must be applied to moisture gasket and into each rack or housing opening for a distance of approx. 1/2 inch.

*Note: For RFI applications "-4" must be used. Rack is supplied with special RSI gasket.

Dash No.	Bezel Finish
- 1	Clear Anodized
- 2	Gray Anodized
- 3	Black Anodized
- 4*	Gold Iridite

MOUNTING FASTENERS

The recommended number of special mounting fasteners are included with shipment of the rack. If additional fasteners are desired or for replacement, they can be ordered by using the part number **800-H1**.

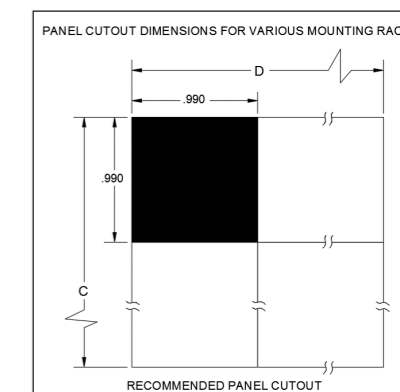

Number of Modules	*Recommended* Minimum No. of Fasteners Per Side				Series 800				Series 820			
	Standard		High-Shock		DIM A	DIM B	DIM C	DIM D	DIM A	DIM B	DIM C	DIM D
	Series 800	Series 820	Series 800	Series 820	±0.015	±0.015	+0.020 -0.000	+0.020 -0.000	±0.015	±0.015	+0.020 -0.000	+0.020 -0.000
1	1	1	1	1	1.150	1.150	.990	.990	1.150	1.410	.990	1.250
2	1	1	2	2	1.950	1.950	1.790	1.790	1.950	2.460	1.790	2.300
3	1	2	3	3	2.750	2.750	2.590	2.590	2.750	3.510	2.590	3.350
4	2	2	4	4	3.550	3.550	3.390	3.390	3.550	4.560	3.390	4.400
5	2	3	5	5	4.350	4.350	4.190	4.190	4.350	5.610	4.190	5.450
6	2	3	6	6	5.150	5.150	4.990	4.990	5.150	6.660	4.990	6.500
7	3	4	7	7	5.950	5.950	5.790	5.790	5.950	7.710	5.790	7.550
8	3	4	8	8	6.750	6.750	6.590	6.590	6.750	8.760	6.590	8.600
9	3	4	9	9	7.550	7.550	7.390	7.390	7.550	9.810	7.390	9.650
10	4	5	10	10	8.350	8.350	8.190	8.190	8.350	10.860	8.190	10.700
11	4	5	11	11	9.150	9.150	8.990	8.990	9.150	11.910	8.990	11.750
12	4	5			9.950	9.950	9.790	9.790	9.950	12.960	9.790	12.800
13	5	5			10.750	10.750	10.590	10.590	10.750	14.010	10.590	13.850
14	5	6			11.550	11.550	11.390	11.390	11.550	15.060	11.390	14.900
15	5	6			12.350	12.350	12.190	12.190	12.350	16.110	12.190	15.950
16	6	6			13.150	13.150	12.990	12.990	13.150	17.160	12.990	17.000
17	6	6			13.950	13.950	13.790	13.790	13.950	18.210	13.790	18.050
18	6	7			14.750	14.750	14.590	14.590	14.750	19.260	14.590	19.100
19	7	7			15.550	15.550	15.390	15.390	15.550	20.310	15.390	20.150
20	7	7			16.350	16.350	16.190	16.190	16.350	21.360	16.190	21.200

WELDED MATRIX, STAINLESS-STEEL, MOUNTING RACKS

800-RX0302-1

800	RX	03	02	1
Series Number	Indicates Stainless-Steel Matrix with Terminal Blocks	Number of Units in Horizontal Axis	Number of Units in Vertical Axis	Panel Thickness

DASH NO.	PANEL THICKNESS	DASH NO.	PANEL THICKNESS
-1	1/32"	-5	5/32"
-2	1/16"	-6	3/16"
-3	3/32"	-7	7/32"
-4	1/8"	-8	1/4"

Welded matrix, stainless-steel mounting racks are available for Series 800 units only. These assemblies are available in pre-assembled matrices in sizes up to 6 x 6 modules as standard. Larger modules and/or other matrices can be fabricated to customer specification. Individual unit mountings are also available in either spring-clip retainer or sleeve-mount versions. All types are supplied with integral plug-in terminal blocks at the base of each individual unit channel, ready for quick, easy wiring.

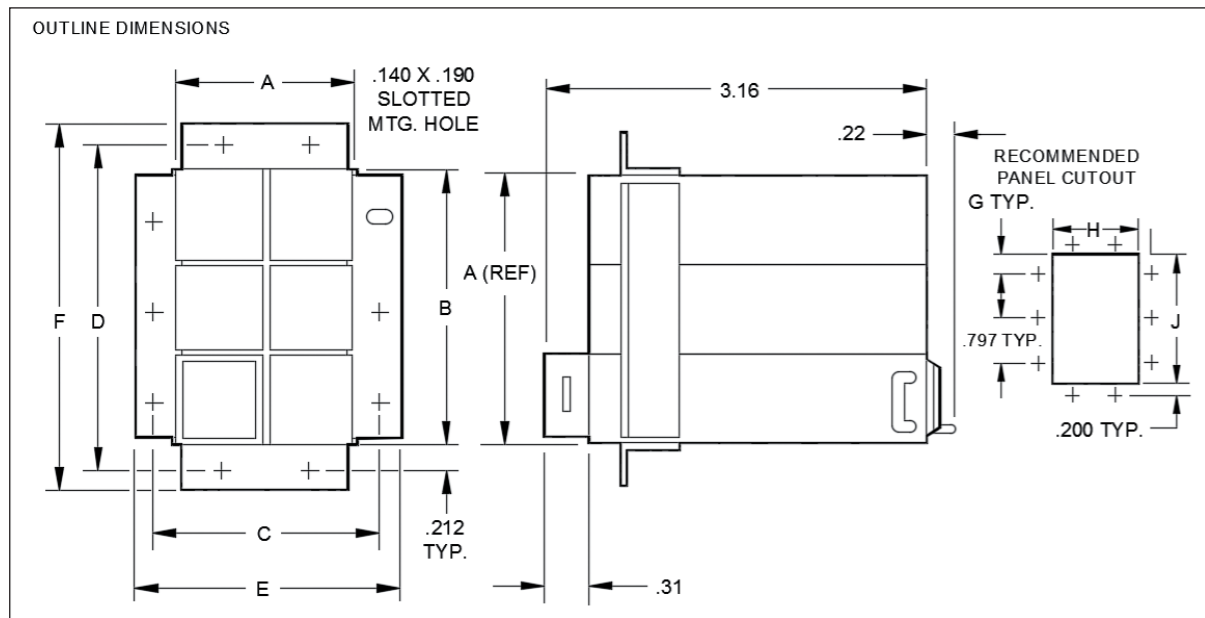

NUMBER OF UNITS ON A SIDE	DIM. A,B MAX.	DIM. E,F MAX.	DIM. C,D	DIM. G ±0.010	DIM. H,J
1	.804	1.508	1.216 - 1.230	.413	.810 - .830
2	1.610	2.385	2.015 - 2.035	.413	1.615 - 1.645
3	2.415	3.190	2.815 - 2.840	.413	2.420 - 2.480
4	3.220	3.995	3.615 - 3.645	.425	3.225 - 3.285
5	4.025	4.795	4.410 - 4.450	.425	4.030 - 4.090
6	4.825	5.600	5.210 - 5.250	.425	4.830 - 4.890

SPRING-CLIP-RETENTION TYPE MOUNTING

Features spring clip retainers on all four sides of the stainless steel frame, which can be specified to fit panel thicknesses from 0.100" to 0.250". To properly order this unit, use **800-R1-** followed by a dash number denoting the proper placement of springs for required panel thickness:

- 1 for panel thickness from 0.100 to 0.150
- 2 for panel thickness from 0.150 to 0.200
- 3 for panel thickness from 0.200 to 0.250

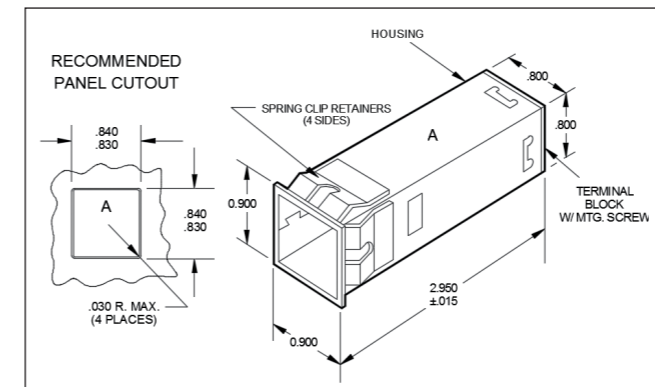

SLEEVE-RETENTION TYPE MOUNTING

Fits any panel thickness requirement from 0.060" to 0.200". To mount, first remove sleeve and insert unit into panel cutout from front. Replace the sleeve at the rear of the panel and tighten the integral mounting screw to draw sleeve up against back of panel and secure unit in place. To order, simply use code number **800-R2-1**.

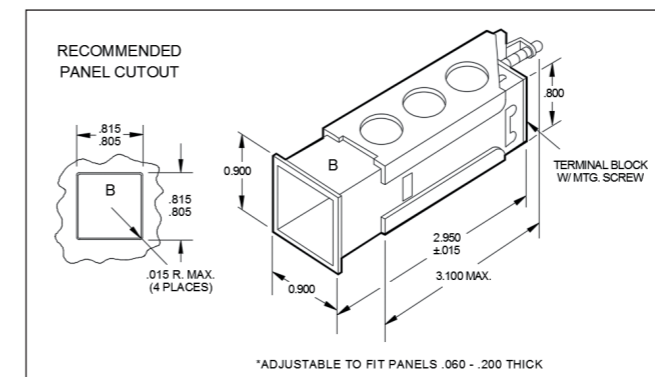

OPTIONAL SLIDE-ON BEZELS

Optional bezels to fit R1 and R2 cans can be specified using the following code:

- 800-506-1** Clear Anodized Finish
- 800-506-2** Gray Anodized Finish
- 800-506-3** Black Anodized Finish

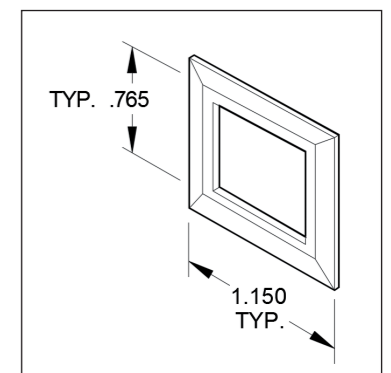

Qualification to MIL-S-22885/80 & /74

The Series 800 and 820 have been granted qualification approval to MIL-S-22885/80 and /74. To order MIL-S-22885/80 or /74 qualified units, the part number should include the letter «H» after the series number 800 or 820.

The list of Safran military specification part numbers for the 800H and 820H series is very extensive and cannot be listed due to space constraints. Should you have a need to order a Military Qualified Products List Part Number, please consult your Safran representative or call the factory.

MIL-S-22885/80 RHW 1x1 Mounting Rack plus Switch

MIL-S-2885/74 800-R2-1 Mounting Can plus Switch

MIL-S-22885/8 RHW Racks up to 1 Ox2 size

MIL-S-22885/82 Lens arrangement

OUR PRESENCE IN THE



SAFRAN GRAND PRAIRIE



**2802 Safran Drive
Grand Prairie, TX 75052**

Over 110 employees

- MRO Support & Service,
- Integrated Cockpit Display,
- System Design & Manufacturing,
- Sales & Marketing of Safran Electronics & Defense portfolio of products.

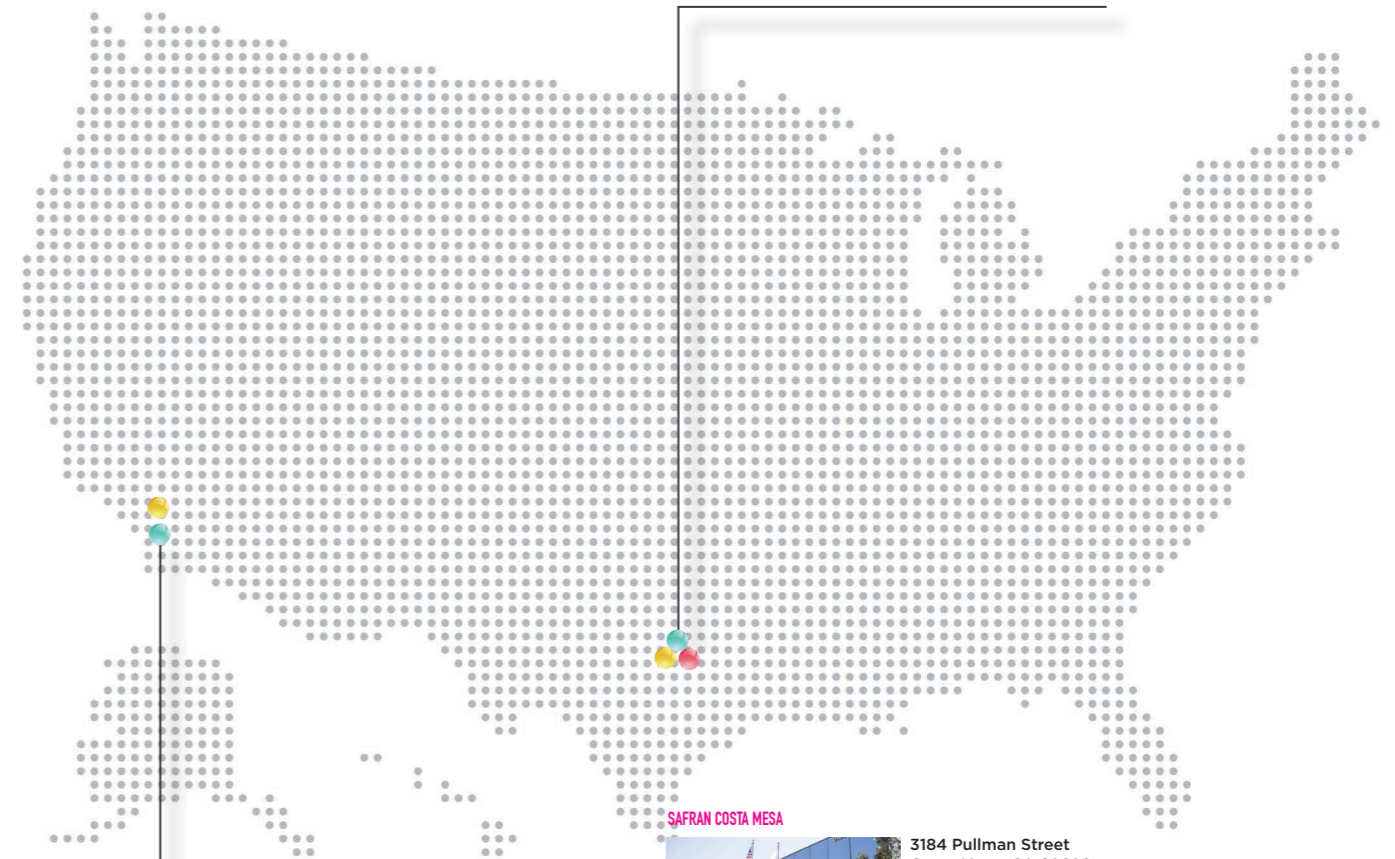

SAFRAN COSTA MESA



**3184 Pullman Street
Costa Mesa, CA 92626**

Over 170 employees

- Illuminated Pushbutton Switches,
- Illuminated Cockpit Control Panel & Dimming Control,
- Pilot Controls,
- Latches.

- Warehouse
- Customer support
- MRO network

With the collaboration of:

Publication director: Cassandra Pereira
Editor in Chief: Roi Rivera, Minh Nguyen
Design and production: Alain & Isabelle
Photo credit: Safran Avionics, Fotolia, Safran, DR
Printed in: United States by Digital Corporate Companies Inc.
D1... SAI - September 2016

**POWERED
BY TRUST**

SAFRAN ELECTRONICS & DEFENSE AVIONICS USA LLC

3184 Pullman Street - CA, 92626

Costa Mesa - USA

Tel. : + 1 949-642-2427

www.safran-electronics-defense.com

