

# ADVANCED MICRO LITES, INC.

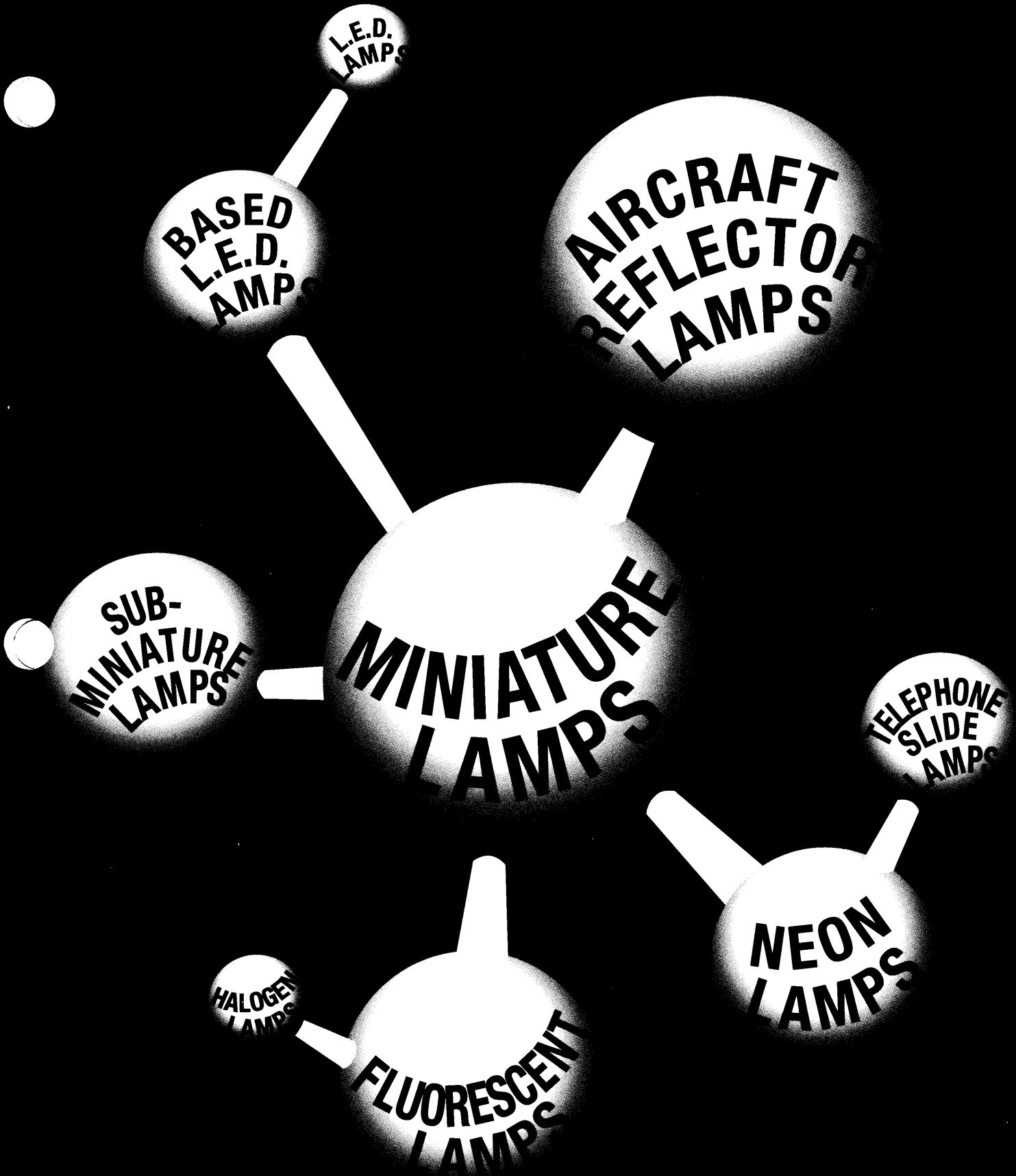

205 N. DEMPSEY, ELBURN, ILLINOIS 60119 1-800-542-1374

TELEPHONE: 630-365-5450 FAX: 630-365-5456

E-MAIL: [sales@advmicrolites.com](mailto:sales@advmicrolites.com)

**AT ADVANCED MICRO LITES, INC., it is our policy to develop, produce and deliver on time, competitive products that are totally acceptable to our customers.**

**QUALITY CONTROL is documented by procedures in accordance with MIL-1-45208A. All shipments are inspected per MIL-STD-105. This inspection covers both electrical and mechanical parameters. Over and above this, a percentage of lamps are checked at intervals for lamp life.**

**Through this catalog we introduce you to our quality products. In addition to the many popular lamp types listed in this catalog, other sizes can be manufactured to your specifications.**

**ADVANCED MICRO LITES, INC.**

**205 N. Dempsey Drive  
Elburn, IL 60119**

**1-800-542-1374**

**(630) 365-5450 Tel. (630) 365-5456 FAX**

**E-Mail: [sales@advmicrolites.com](mailto:sales@advmicrolites.com)**

# General Information

## Design Volts

Design voltage indicates the voltage at which the lamp's design amperes, candlepower and average life can be realized.

## MSCP

Mean Spherical Candlepower (MSCP) is a value of the total light output of a lamp operated at design volts, when measured in an integrating sphere. MSCP can be converted to lumens by multiplying 12.57 ( $4\pi$  by MSCP). AS25 suffix indicates MSCP tolerance of  $\pm 25\%$ , AS15 suffix indicates lamp is aged and selected to a MSCP tolerance of  $\pm 15\%$ .

## Design Amperes

Design Amperes is the value of current flowing through a lamp when operated at its design voltage. The current flow value (design amperes) shall be within the range of  $\pm 10\%$  unless otherwise stated.

## Rated Life

Rated Average Laboratory Life (hours) is the average life obtained in closely controlled laboratory-life testing at their design voltage  $\pm 1\%$ . It is not necessarily the same as service life where conditions such as shock, vibration, voltage fluctuations and environment may result in a shortened average attained life. Also DC operation may substantially reduce lamp life on some lamp types.

## Filament Configurations

Filament designs are designated by a combination of letters indicating the filament wire configuration and a number which identifies its arrangement on the lead and support wires.

### Single Filament Styles

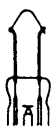

S-2



C-2F

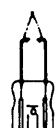

C-2V



C-2R



C-5



C-6



C-7A

### Double Filament Styles



2/C2R



2CC-6



2C-6



C-2V/C-6



C-6/C-6

## Bulb Shapes

Bulb shapes are identified by a combination of letters and numbers; the letter indicates the shape of the bulb, and the number indicates the approximate diameter of the bulb in eighths of an inch.

### Typical Bulb Shapes

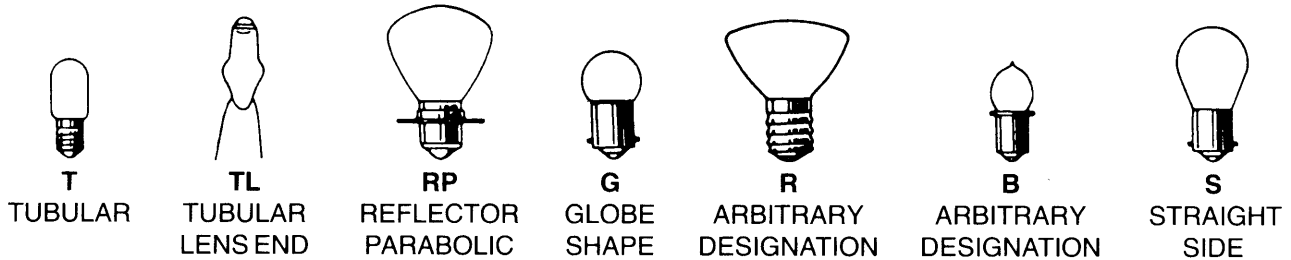

### Bases

Bases provide electrical contact to the lamp and, in most cases, supports the lamp in the fixture. There are many styles and sizes of bases available, as evidenced by the illustrations below.

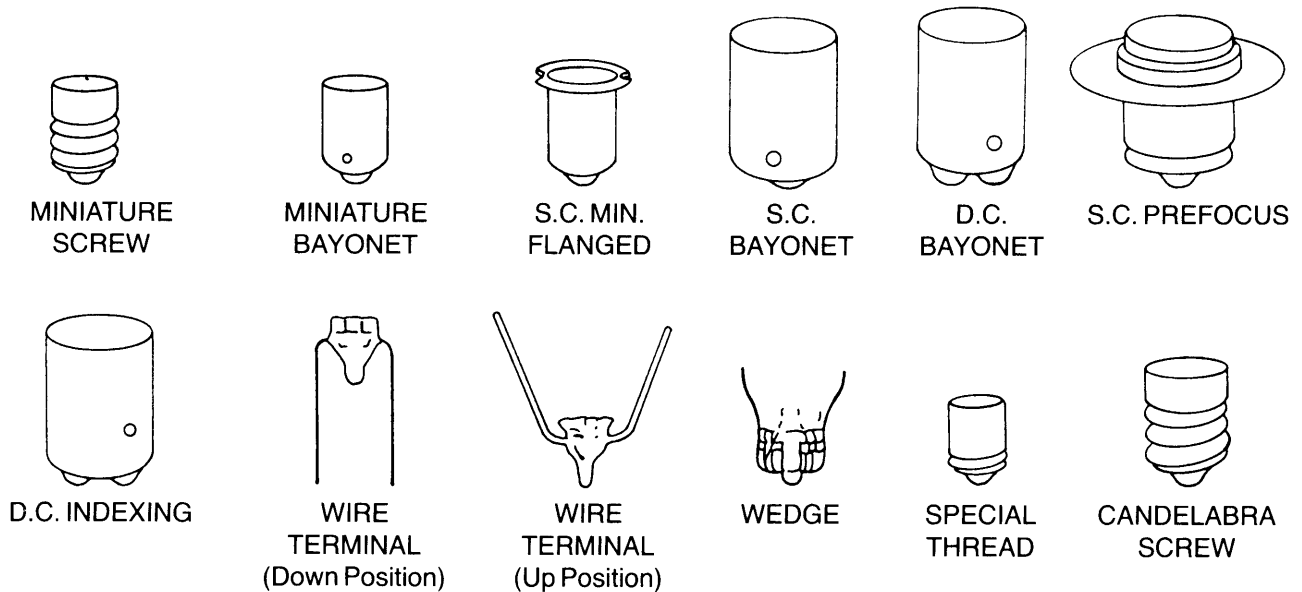

■ **B-3 1/2** LAMPS

FLASHLITE PREFOCUS

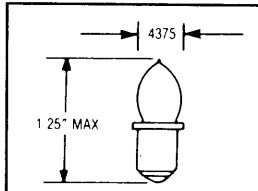

Design Volts	Design Amps	Candle Power	Filament Shape	Average Life (Hours)	S.C. MINIATURE FLANGED LAMP NUMBER
2.33	.27	.4	C-2R	10	PR-4
2.38	.50	.8	C-2R	15	PR-2
2.4	.70	1.3	C-2R	15	PR-31
2.47	.30	.45	C-2R	30	PR-6
3.57	.50	1.5	C-2R	15	PR-3
3.7	.30	.9	C-2R	30	PR-7
3.75	.86	2.25	C-2R	40	PR-30
4.75	.50	2.0	C-2R	15	PR-13
4.8	.70	3.5	C-2R	15	PR-32
4.82	.50	2.0	C-2R	30	PR-15
5.95	.50	3.0	C-2R	15	PR-12
7.2	.55	4.2	C-2R	30	PR-18
8.63	.50	5.0	C-2R	15	PR-20
12.5	.25	2.7	C-2R	50	PR-16

Consult factory for Krypton Lamps.

■ **B-6** LAMPS

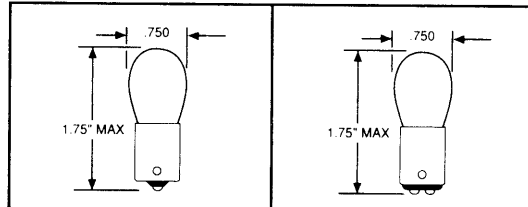

Design Volts	Design Amps	Candle Power	Filament Shape	Average Life (Hours)	S.C. BAYONET LAMP NUMBER	D.C. BAYONET LAMP NUMBER
6.0	.45	3.4	C-6	100	1317	
12.8	.94	15.0	C-6	100	1003	1004
28.0	.52	15.0	2CC-6	300	1309	

■ **G-2** LAMPS

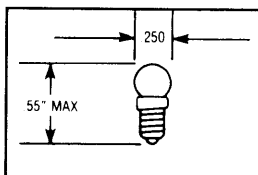

Design Volts	Design Amps	Candle Power	Filament Shape	Average Life (Hours)	MIDGET SCREW LAMP NUMBER
28.0	.04	.32	C-2F	1,000	333

FOR ADDITIONAL LAMPS NOT LISTED IN THIS CATALOG, PLEASE CONTACT AML DIRECT.

ADVANCED **A** MICRO LITES, INC.

■ **G-3 1/2** LAMPS

Design Volts	Design Amps	Candle Power	Filament Shape	Average Life (Hours)	MINIATURE SCREW LAMP NUMBER	MINIATURE BAYONET LAMP NUMBER	MINIATURE 2 PIN LAMP NUMBER
1.25	.30	.10	S-2	10	123		
1.3	.10	.03	S-2	50	131		
2.46	.50	.90	C-2R	15	245		
2.47	.30	.50	C-2R	15	14		
2.5	.50	.50	C-6	3,000			10
3.7	.30	.98	C-2R	15	13		
6.3	.15	.35	C-6	5,000			12
6.3	.15	.32	C-2R	5,000		130	
6.3	.25	.50	C-2V	5,000		219	
7.5	.22	1.0	C-2R	1,000	50	51	
12.0	.20	1.7	C-2R	250	1446		
14.0	.20	2.0	C-2V	250	1449	363	
14.4	.10	.90	C-6	1,000			19
14.4	.10	.75	C-2V	1,000	52		
14.4	.12	1.0	C-2V	1,000		53	
14.4	.135	.70	C-2V	2,000		1445	
18.0	.15	1.5	C-2V	250	1447		
24.0	.035	.23	C-2V	3,000		1450	
28.0	.17	3.5	C-2V	500		356	

■ **G-4 1/2** LAMPS

Design Volts	Design Amps	Candle Power	Filament Shape	Average Life (Hours)	MINIATURE SCREW LAMP NUMBER	MINIATURE BAYONET LAMP NUMBER
4.9	.30	1.4	C-2R	30	27	
4.9	.30		C-2R	50	407*	
5.0	.50	2.3	C-2R	15	425	
5.1	.15	.6	C-2R	100	502	503
6.15	.50	3.40	C-2R	15	605	
6.5	.50	1.9	C-2R	500		455*
7.0	.41	2.0	C-2R	500		55
12.5	.25	2.4	C-2V	250	428	
14.0	.24	2.0	C-2V	500		57
14.0	.27		C-2R	500		257*
14.0	.27	2.0	C-2F	1,500		1895
14.0	.33	2.0	C-2F	5,000		293
28.0	.17	2.0	C-2F	5,000		456

FOR ADDITIONAL LAMPS NOT LISTED IN THIS CATALOG, PLEASE CONTACT AML DIRECT.

\*Indicates flasher lamp

**■ B-3 1/2 LAMPS**

FLASHLITE PREFOCUS

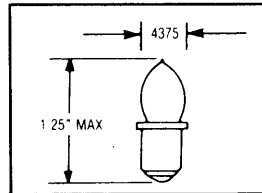

Design Volts	Design Amps	Candle Power	Filament Shape	Average Life (Hours)	S.C. MINIATURE FLANGED LAMP NUMBER
2.33	.27	.4	C-2R	10	PR-4
2.38	.50	.8	C-2R	15	PR-2
2.4	.70	1.3	C-2R	15	PR-31
2.47	.30	.45	C-2R	30	PR-6
3.57	.50	1.5	C-2R	15	PR-3
3.7	.30	.9	C-2R	30	PR-7
3.75	.86	2.25	C-2R	40	PR-30
4.75	.50	2.0	C-2R	15	PR-13
4.8	.70	3.5	C-2R	15	PR-32
4.82	.50	2.0	C-2R	30	PR-15
5.95	.50	3.0	C-2R	15	PR-12
7.2	.55	4.2	C-2R	30	PR-18
8.63	.50	5.0	C-2R	15	PR-20
12.5	.25	2.7	C-2R	50	PR-16

Consult factory for Krypton Lamps.

**■ B-6 LAMPS**

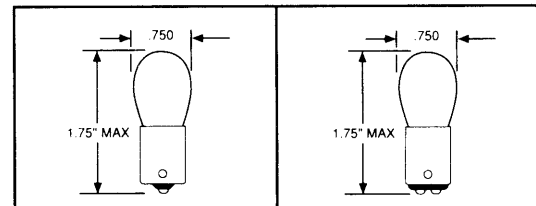

Design Volts	Design Amps	Candle Power	Filament Shape	Average Life (Hours)	S.C. BAYONET LAMP NUMBER	D.C. BAYONET LAMP NUMBER
6.0	.45	3.4	C-6	100	1317	
12.8	.94	15.0	C-6	100	1003	1004
28.0	.52	15.0	2CC-6	300	1309	

**■ G-2 LAMPS**

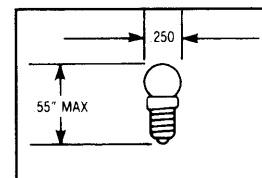

Design Volts	Design Amps	Candle Power	Filament Shape	Average Life (Hours)	MIDGET SCREW LAMP NUMBER
28.0	.04	.32	C-2F	1,000	333

FOR ADDITIONAL LAMPS NOT LISTED IN THIS CATALOG, PLEASE CONTACT AML DIRECT.

ADVANCED **A** MICRO LITES,  
INC.

■ **G-3 1/2** LAMPS

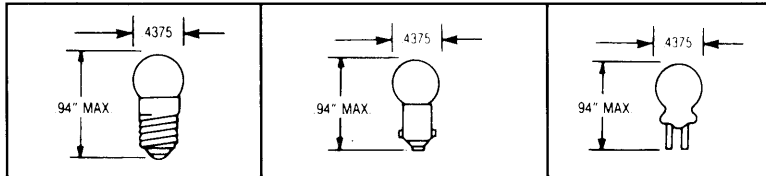

Design Volts	Design Amps	Candle Power	Filament Shape	Average Life (Hours)	MINIATURE SCREW LAMP NUMBER	MINIATURE BAYONET LAMP NUMBER	MINIATURE 2 PIN LAMP NUMBER
1.25	.30	.10	S-2	10	123		
1.3	.10	.03	S-2	50	131		
2.46	.50	.90	C-2R	15	245		
2.47	.30	.50	C-2R	15	14		
2.5	.50	.50	C-6	3,000			10
3.7	.30	.98	C-2R	15	13		
6.3	.15	.35	C-6	5,000			12
6.3	.15	.32	C-2R	5,000		130	
6.3	.25	.50	C-2V	5,000		219	
7.5	.22	1.0	C-2R	1,000	50	51	
12.0	.20	1.7	C-2R	250	1446		
14.0	.20	2.0	C-2V	250	1449	363	
14.4	.10	.90	C-6	1,000			19
14.4	.10	.75	C-2V	1,000	52		
14.4	.12	1.0	C-2V	1,000		53	
14.4	.135	.70	C-2V	2,000		1445	
18.0	.15	1.5	C-2V	250	1447		
24.0	.035	.23	C-2V	3,000		1450	
28.0	.17	3.5	C-2V	500		356	

■ **G-4 1/2** LAMPS

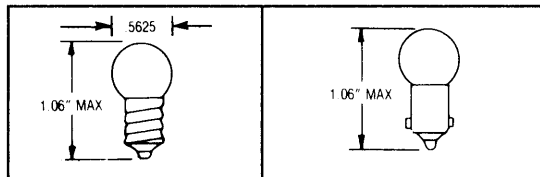

Design Volts	Design Amps	Candle Power	Filament Shape	Average Life (Hours)	MINIATURE SCREW LAMP NUMBER	MINIATURE BAYONET LAMP NUMBER
4.9	.30	1.4	C-2R	30	27	
4.9	.30		C-2R	50	407*	
5.0	.50	2.3	C-2R	15	425	
5.1	.15	.6	C-2R	100	502	503
6.15	.50	3.40	C-2R	15	605	
6.5	.50	1.9	C-2R	500		455*
7.0	.41	2.0	C-2R	500		55
12.5	.25	2.4	C-2V	250	428	
14.0	.24	2.0	C-2V	500		57
14.0	.27		C-2R	500		257*
14.0	.27	2.0	C-2F	1,500		1895
14.0	.33	2.0	C-2F	5,000		293
28.0	.17	2.0	C-2F	5,000		456

FOR ADDITIONAL LAMPS NOT LISTED IN THIS CATALOG, PLEASE CONTACT AML DIRECT.

\*Indicates flasher lamp



# ADVANCED MICRO LITES, INC.

## INCANDESCENT LAMPS

### ■ G-5 LAMPS

Design Volts	Design Amps	Candle Power	Filament Shape	Average Life (Hours)	S.C. BAYONET LAMP NUMBER	D.C. BAYONET LAMP NUMBER
2.5	1.00	1.75	C-6	20	1315	
28.0	.17	3.00	C-2F	500	301	302

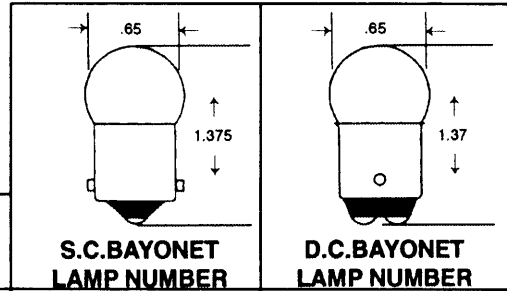

### ■ G-6 LAMPS

Design Volts	Design Amps	Candle Power	Filament Shape	Average Life (Hours)	S.C. BAYONET LAMP NUMBER	D.C. BAYONET LAMP NUMBER
6.5	1.02	6.0	C-2R	500	81	82
7.0	.63	3.0	C-2R	1,000	63	64
13.0	.58	6.0	C-2R	750	89	90
13.5	.59	4.0	C-2R	5,000	67	68
13.5	.69	4.0	C-2V	5,000	97	
28.0	.23	3.0	2CC-6	2,000	1251	1252
28.0	.30	6.0	C-2F	500	303	304
28.0	.37	6.0	2CC-6	1,000	623	624

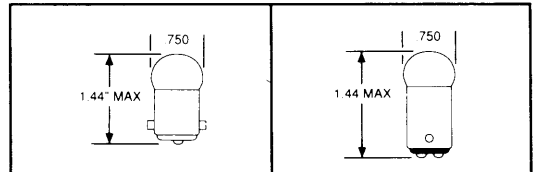

### ■ R-12 LAMPS

Design Volts	Design Amps	Candle Power	Filament Shape	Average Life (Hours)	S.C. BAYONET LAMP NUMBER
13.0	1.50		C-8	300	1383
28.0	.72		CC-8	300	1385

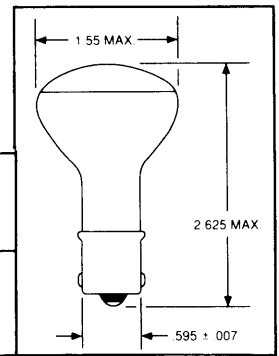

### ■ RP-11 LAMPS

Design Volts	Design Amps	Candle Power	Filament Shape	Average Life (Hours)	S.C. BAYONET LAMP NUMBER	D.C. BAYONET LAMP NUMBER
6.2	3.91	32.0	C-2R	200	1133	
12.5	3.0	50.0	C-2V	300	1195	1196
26.0	2.7	105.0	2CC-6	25	1047	
40.0	.92	50.0	C-5	100		1062

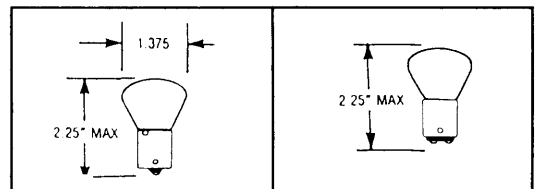

FOR ADDITIONAL LAMPS NOT LISTED IN THIS CATALOG, PLEASE CONTACT AML DIRECT.

ADVANCED **A** MICRO LITES,  
INC.

■ **S-6 STANDARD VOLTAGE LAMPS**

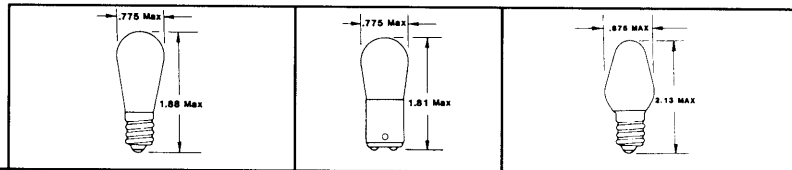

Design Volts	Watts	Bulb Size And Type	Filament Shape	Average Life (Hours)	CANDELABRA SCREW LAMP NUMBER	D.C. BAYONET LAMP NUMBER	CANDELABRA SCREW LAMP NUMBER
6	6.0	S-6	C-7A	1,500	6S6/6		
12	6.0	S-6	C-7A	1,500	6S6/12		
24	6.0	S-6	C-7A	1,500	6S6/24		
30	6.0	S-6	C-7A	1,500	6S6/30		
48	6.0	S-6	C-7A	1,500	6S6/48		
60	6.0	S-6	C-7A	1,500	6S6/60		
120	3.0	S-6	C-7A	1,500	3S6/120		
120	6.0	S-6	C-7A	1,500	6S6/120	6S6DC/120	
135	6.0	S-6	C-7A	1,500	6S6/135	6S6DC/135	
145	6.0	S-6	C-7A	1,500	6S6/145	6S6DC/145	
155	6.0	S-6	C-7A	1,500	6S6/155	6S6DC/155	
250	6.0	S-6	C-7A	1,500	6S6/250	6S6DC/250	
115-125	10.0	S-6	C-7A	1,500	10S6/120		
230-250	10.0	S-6	C-7A	1,500	10S6/250	10S6DC/250	
115-125	7.0	C-7	C-7A	3,000			7C7

■ **S-8 LAMPS**

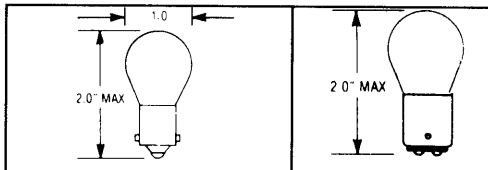

Design Volts	Design Amps	Candle Power	Filament Shape	Average Life (Hours)	S.C. BAYONET LAMP NUMBER	D.C. BAYONET LAMP NUMBER
5.0	.60	3.0	C-2R	20	1651	
6.0	4.10	32.0	C-6	300	1680	
6.4	2.63	21.0	C-6	200	1129	1130
6.4	3.0	23.0	C-2R	500		6
6.5	2.75	23.0	C-6	100		1493
6.7	1.90	15.0	C-6	500	1619	
6.8	1.91	15.0	C-2R	300	87	88
12.5	3.0	50.0	C-2R	200	1295	
12.8	1.04	15.0	C-2R	500	93	94
12.8	1.44	21.0	C-6	1000	1141	1142
12.8	1.80	32.0	C-6	200	1073	1076
12.8	2.10	32.0	C-6	1200	1156	
12.8	2.25	32.0	C-6	1200	199	
28.0	.51	15.0	C-2V	300	305 <sup>(1)</sup>	306
28.0	.61	15.0	2CC-6	1000	1691	1692
28.0	.643	17.0	CC-8	2000	2232	
28.0	.67	21.0	C-2V	300	307 <sup>(1)</sup>	308
28.0	.71	21.0	C-2V	400	1203	1204
28.0	.766	21.0	CC-8	2000	2233	
28.0	.80	21.0	C-2V	1000	1665	
28.0	.90	32.0	C-2V	300	315	
28.0	1.02	32.0	2C-6	500	1683	
32.0	.45	15.0	C-2V	150		1228
40.0	.53	14.0	C-13	3800		595

FOR ADDITIONAL LAMPS NOT LISTED IN THIS CATALOG, PLEASE CONTACT AML DIRECT.

<sup>(1)</sup> AVAILABLE IN INSIDE FROSTED.

# ADVANCED MICRO LITES, INC.

## INCANDESCENT LAMPS

### ■ S-8 LAMPS

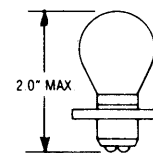
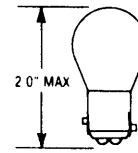

Design Volts	Design Amps	Candle Power	Filament Shape	Average Life (Hours)	D.C. INDEX LAMP NUMBER	D.C. PREFOCUS LAMP NUMBER
12.8 14.0	1.34 .59	21.0 6.0	2C-6	200 1000	1176	
12.8 14.0	1.80 .59	32.0 3.0	2C-6	200 5000	1034 <sup>Ⓢ</sup>	
12.8 14.0	2.10 .59	32.0 3.0	2C-6	600 500	1157 <sup>Ⓢ</sup>	
28.0 28.0	.93 .34	32.0 6.0	CC-6 C-2V	400 1000	1662	
6.5 6.5 6.5	2.75 2.75 2.75	18.0 23.0 23.0	C-6 C-6 C-6	100 100 100		1630 1460 1460X <sup>Ⓢ</sup>

- Ⓢ X SILVER CONTACTS
- Ⓢ AVAILABLE IN AMBER

### ■ S-8 LAMPS

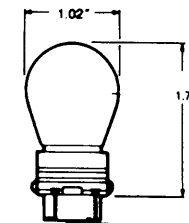
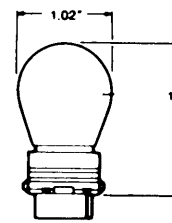

Design Volts	Design Amps	Candle Power	Filament Shape	Average Life (Hours)	WEDGE LAMP NUMBER	WEDGE LAMP NUMBER
12.8	2.1	32.0	C-6	1,200	3156	
12.8 14.0	2.1 .59	32.0 3.0	C-6 C-6	1,200 5,000		3157

### ■ S-11 LAMPS

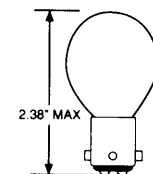
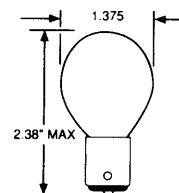

Design Volts	Design Amps	Candle Power	Filament Shape	Average Life (Hours)	S.C. BAYONET LAMP NUMBER	D.C. BAYONET LAMP NUMBER
28.0 28.0 28.0	.90 1.29 1.29	32.0 50.0 44.0	C-2V C-2V CC-6	300 300 1000	309 311 3011	312

FOR ADDITIONAL LAMPS NOT LISTED IN THIS CATALOG, PLEASE CONTACT AML DIRECT.

ADVANCED MICRO LITES,  
INC.

**T-3/4 LAMPS**

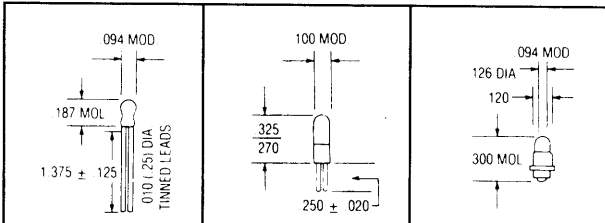

Design Volts	Design Amps	Candle Power	Filament Shape	Average Life (Hours)	WIRE TERMINAL LAMP NUMBER	BI-PIN LAMP NUMBER	MIDGET FLANGED LAMP NUMBER
5.0	.021	.03	C-2R	10,000	2	7112	
5.0	.06	.05	C-2R	25,000	6833		
5.0	.06	.15	C-2R	3,000	6153		
5.0	.075	.09	C-2R	25,000	7133		
5.0	.08	.15	C-2R	15,000	8666		
5.0	.115	.15	C-2R	40,000	7153		8270

**T-1 STANDARD LAMPS**

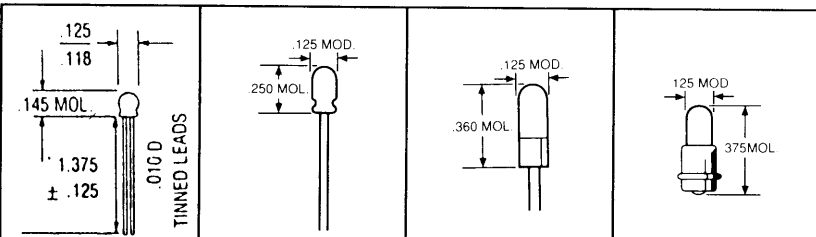

Design Volts	Design Amps	Candle Power	Filament Shape	Average Life (Hours)	SHORT T-1 LAMP NUMBER	WIRE TERMINAL LAMP NUMBER	BI-PIN LAMP NUMBER	MIDGET FLANGED LAMP NUMBER
1.5	.075	.03	C-2R	16,000		7203		
2.5	.10	.10	C-2R	10,000			7732	
5.0	.02	.03	C-2R	10,000	2022	6022		
5.0	.03	.03	C-2F	16,000		7210	7263	7234
5.0	.06	.03	C-2R	60,000	6802	680		682
5.0	.06	.05	C-2R	25,000	6832	683	7683	685
5.0	.06	.15	C-2R	5,000	6152	6150	7265	6180
5.0	.075	.09	C-2R	25,000	7132	713	7714	714
5.0	.08	.15	C-2R	3,000				7235
5.0	.115	.15	C-2R	40,000	7152	715	7715	718
5.0	.115	.15	C-2R	16,000		6809*		
5.0	.125	.25	C-2R	5,000		7216		
10.0	.027	.10	C-2F	10,000			8095	7240
12.0	.06	.15	C-2F	10,000		7219	8097	32
14.0	.065	.15	C-2F	10,000		8111	8098	8112
18.0	.026	.15	C-2F	10,000		7220	8099	7241
28.0	.024	.15	CC-2F	16,000		6838	7839	6839
28.0	.020	.15	CC-2F	10,000	7009			

\*Helium Retardant

FOR ADDITIONAL LAMPS NOT LISTED IN THIS CATALOG, PLEASE CONTACT AML DIRECT.

ADVANCED **A** INC. MICRO LITES,

■ **T-1<sup>1</sup>/<sub>4</sub>** LAMPS

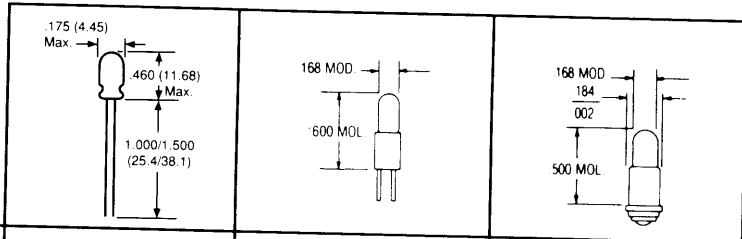

Design Volts	Design Amps	Candle Power	Filament Shape	Average Life (Hours)	WIRE TERMINAL LAMP NUMBER	BI-PIN LAMP NUMBER	SPECIAL MIDGET FLANGED LAMP NUMBER
5.0	.115	.150	C-2R	40,000	515	7515	8637
3.0	.19	.25	C-2R	350	324		
6.0	.06	.13	C-2R	3,000	2114		
6.0	.20	.63	C-2R	1,000	634	7646 7632	8628
14.0	.08	.50	C-2F	1,000	8640		
28.0	.04	.32	C-2F	1,000	8627		
28.0	.05	.30	C-2F	16,000			
							737

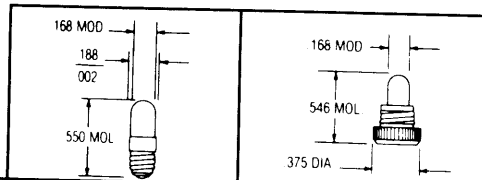

Design Volts	Design Amps	Candle Power	Filament Shape	Average Life (Hours)	SPECIAL SCREW LAMP NUMBER	KNURLED SCREW LAMP NUMBER
3.0	.19	.25	C-2R	350	325	323
4.5	.29	1.05	C-2R	100	673	
6.0	.20	.63	C-2R	1,000	8645	8623
6.3	.20	.55	C-2R	1,000	8552	
28.0	.04	.32	C-2F	1,000		

■ **T-1<sup>1</sup>/<sub>2</sub>** LAMPS

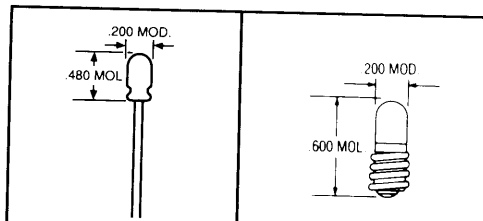

Design Volts	Design Amps	Candle Power	Filament Shape	Average Life (Hours)	WIRE TERMINAL LAMP NUMBER	MIDGET SCREW LAMP NUMBER
2.5	.20	.10	C-2R	500	8190	8189
6.0	.20	.75	C-2R	350	8192	8191
28.0	.04	.34	C-2F	1,000	8194	8193

FOR ADDITIONAL LAMPS NOT LISTED IN THIS CATALOG, PLEASE CONTACT AML DIRECT.

ADVANCED MICRO LITES, INC.

■ T-1<sup>3</sup>/<sub>4</sub> LAMPS

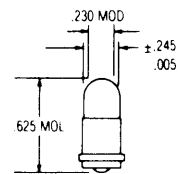
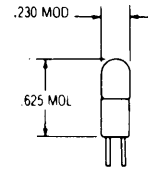
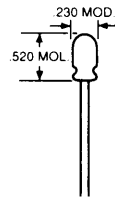

Design Volts	Design Amps	Candle Power	Filament Shape	Average Life (Hours)	WIRE TERMINAL LAMP NUMBER	BI-PIN LAMP NUMBER	MIDGET FLANGED LAMP NUMBER
1.35	.06	.01	C-6	500	1728		331
2.5	.20	.22	C-2R	500			368
2.5	.35	.20	C-2R	10,000	2169		268
2.7	.06	.04	C-2R	6,000	1738		338
3.0	.015	.003	C-6	10,000	2158		375
5.0	.06	.05	C-2R	25,000	2200	7361	7333
5.0	.06	.15	C-2R	5,000			3150
5.0	.115	.15	C-2R	40,000	2203	7362	
6.0	.04	.03	C-2V	10,000	1730		345
6.0	.20	.60	C-2R	1,000			328*
6.0	.20	.60	C-2R	1,000	1784	7328	
6.3	.04	.02	C-2V	20,000	2180	7380	380
6.3	.075	.23	C-2R	1,000	1739	7377	377
6.3	.15	.45	C-2R	3,000			350
6.3	.20	.40	C-2F	20,000	2181	7381	381
6.3	.20	.55	C-2R	5,000	2112	7349	349
10.0	.014	.002	C-2F	50,000	1869		344
10.0	.04	.08	C-2F	5,000		7367	367
12.0	.04	.12	C-2F	10,000	2174	7371	394
14.0	.08	.30	C-2F	15,000	2182	7382	382
14.0	.08	.50	C-2F	1,500	1705	7330	330
14.0	.10	.50	C-2F	10,000	2162	7373	8918
18.0	.04	.15	C-2F	10,000	2102	7370	370
22.0	.04	.30	C-2F	2,000			459
24.0	.05	.50	C-2F	1,000	2176	7001	
28.0	.04	.15	C-2F	10,000	2185	7374	385
28.0	.04	.30	C-2F	7,000	2187	7387	387
28.0	.04	.34	C-2F	4,000	1764	7327	327
28.0	.06	.34	C-2F	25,000		7876	376
28.0	.065	.65	C-2F	5,000		7376	7341
48.0	.025	.20	C-2F	5,000			6848

\* .340 MSCP @ 5.0 V / MS

FOR ADDITIONAL LAMPS NOT LISTED IN THIS CATALOG, PLEASE CONTACT AML DIRECT.

■ **T-1<sup>3</sup>/<sub>4</sub>** LAMPS (Continued)

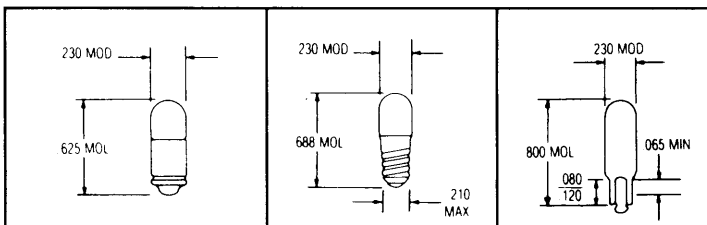

Design Volts	Design Amps	Candle Power	Filament Shape	Average Life (Hours)	MIDGET GROOVED LAMP NUMBER	MIDGET SCREW LAMP NUMBER	WEDGE LAMP NUMBER
2.5	.20	.20	C-2R	500		1769	
6.0	.04	.03	C-2R	10,000		342	
6.0	.20	.60	C-2R	1,000	337	1768	
6.3	.075	.23	C-2R	1,000		1775	
6.3	.20	.40	C-2F	20,000	379	378	86
6.3	.20	.55	C-2F	5,000	398		
10.0	.04	.08	C-2F	5,000	397		
12.0	.04	.12	C-2F	10,000	7354		
14.0	.08	.30	C-2F	15,000	386	8362	73
14.0	.08	.50	C-2F	1,500	336	373	
14.0	.09	.50	C-2F	1,500			37
14.0	.10	.70	C-2F	500			74
18.0	.04	.15	C-2F	10,000	346		
28.0	.04	.15	C-2F	10,000	7355		
28.0	.04	.30	C-2F	7,000	388	399	85
28.0	.04	.34	C-2F	4,000	334	335	
28.0	.06	.34	C-2F	25,000	276	335LSV	

FOR ADDITIONAL LAMPS NOT LISTED IN THIS CATALOG, PLEASE CONTACT AML DIRECT.

**T-2 FUSE STYLE LAMPS**

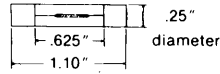

Design Volts	Design Amps	Candle Power	Filament Shape	Average Life (Hours)	(3AG) FUSE STYLE LAMP NUMBER
6.0	.20	.40	C-8	5,000	GF550
8.0	.25	.64	C-8	5,000	GF670
12.6	.30	.64	C-8	5,000	GF740

**T-2 SLIDE BASED TELEPHONE LAMPS**

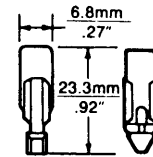
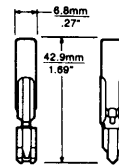

Design Volts	Design Amps	Candle Power	Filament Shape	Average Life (Hours)	SLIDE BASED LAMP NUMBER	LAMP NUMBER
12.0	.10	1200	C-2F	1,000	12A	
18.0	.04	800	C-2F	1,000	18A	
18.0	.10	600	C-2F	10,000	18B	
24.0	.04	1000	C-2F	5,000	24B	
24.0	.035	600	C-2F	5,000	24E	
24.0	.035	600	C-2F	5,000	24X	
35.0	.04	1000	C-2F	3,000	35A	
10.0	.036	275	C-6	10,000		51A

**LILLIPUT TELEPHONE SWITCHBOARD LAMPS**

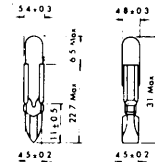
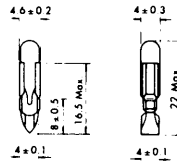

Design Volts	Design Amps	Candle Power	Filament Shape	Average Life (Hours)	T4.6 LAMP NUMBER	T5.5 LAMP NUMBER
12.0	.050	.127	C-2V	6,000	T4.6 12/50	
24.0	.020	.055	C-2F	8,000	T4.6 24/20	T5.5 24/20
24.0	.030	.111	C-2F	5,000		T5.5 24/30
24.0	.050	.239	C-2F	6,000	T4.6 24/50	T5.5 24/50
30.0	.040	.287	C-2F	6,000	T4.6 30/40	T5.5 30/40

FOR ADDITIONAL LAMPS NOT LISTED IN THIS CATALOG, PLEASE CONTACT AML DIRECT.



■ **T-2 & T-2½**  
**TELEPHONE LAMPS**

Design Volts	Design Amps	Candle Power	Filament Shape	Average Life (Hours)	SLIDE BASED LAMP NUMBER	MINIATURE BAYONET LAMP NUMBER	SLIDE BASED LAMP NUMBER
6.0	.14	.12	C-2F	20,000	6PSB		
10.0	.04	.07	C-2V	5,000			10ESB
12.0	.04	.09	C-2V	15,000			12ESB
12.0	.17	.48	C-2F	12,000	12PSB	12MB	
24.0	.017	.02	C-2F	15,000			24CSB
24.0	.04	.12	C-2F	8,000			24ESB
24.0	.073	.85	C-2F	10,000	24PSB	24MB	
28.0	.04	.17	C-2F	5,000	28PSB	28MB	
28.0	.04	.25	C-2F	6,000			28ESB
48.0	.04	.44	C-2F	5,000			48ESB
48.0	.053	.52	C-7A	10,000	48PSB	48MB	
60.0	.05	.67	C-7A	7,500	60PSB	60MB	
90.0	.03	.37	CC-7A	5,000		90MB	
120.0	.025	.36	CC-7A	5,000	120PSB	120MB	
155.0	.019	.20	CC-7A	5,000	155PSB	155MB	

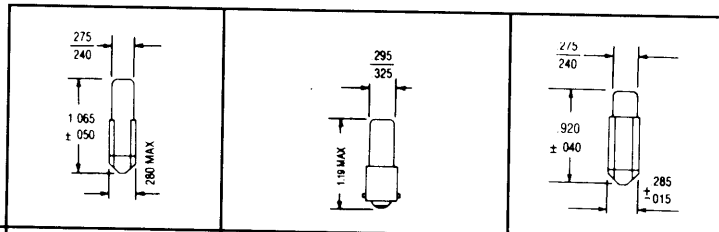

FOR ADDITIONAL LAMPS NOT LISTED IN THIS CATALOG, PLEASE CONTACT AML DIRECT.

**ADVANCED MICRO LITES, INC.**

**T-3 1/4 MINIATURE SIZE LAMPS**

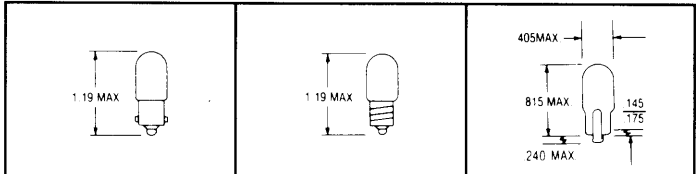

Design Volts	Design Amps	Candle Power	Filament Shape	Average Life (Hours)	MINIATURE BAYONET LAMP NUMBER	MINIATURE SCREW LAMP NUMBER	WEDGE LAMP NUMBER
2.0	.06	.04	S-2	1,000	49	48	
2.5	.50	.50	C-2R	3,000	43	41	
3.2	.35	.50	C-2R	3,000	45	42	
3.2	.16	.20	C-2R	3,000	1490		
5.0	.09	.25	C-2R	1,500	1850		
6.3	.15	.33	C-2R	20,000	755		159
6.3	.15	.38	C-2R	5,000	1847		
6.3	.15	.50	C-2R	3,000	47	40	447
6.3	.25	.65	C-2R	5,000	1866		259
6.3	.25	.90	C-2R	3,000	44	46	555
6.3	.36		C-2R	5,000	239		
6.3	.40	1.40	C-2R	3,000	1810		
6.3	.50	2.0	C-2R	2,000	238		
7.0	.50	2.0	C-2R	1,500	1888		
10.0	.13	.80	C-2V	250	1408		
13.0	.33	3.0	C-2V	1,000	1816		
14.0	.08	.31	C-2F	15,000	756		658
14.0	.15	1.5	C-2V	200	1488		
14.0	.19	1.0	C-2F	1,500			161
14.0	.20	1.4	C-2V	3,000	1815	1487	
14.0	.24	2.0	C-2F	500	1891		158
14.0	.27		C-2R	500	256 (flasher)		
14.0	.27	2.0	C-2F	2,500	1889		194
14.0	.33	2.0	C-2F	7,500	1893		
14.0	.35	3.0	C-2F	1,500			168

FOR ADDITIONAL LAMPS NOT LISTED IN THIS CATALOG, PLEASE CONTACT AML DIRECT.

■ **T-3<sup>1</sup>/<sub>4</sub> MINIATURE  
SIZE LAMPS** (Continued)

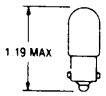
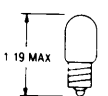
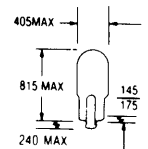
Design Volts	Design Amps	Candle Power	Filament Shape	Average Life (Hours)	  		
					MINIATURE BAYONET LAMP NUMBER	MINIATURE SCREW LAMP NUMBER	WEDGE LAMP NUMBER
14.4	.10	.86	C-2V	1,000	1813		
14.4	.12	.75	C-2F	1,000	1892		
24.0	.17	3.30	C-2V	250	1818		
28.0	.022	.20	C-2F	3,000	1843		
28.0	.04	.30	C-2F	7,000			585
28.0	.04	.34	C-2F	2,500	1819		
28.0	.06	.62	C-2F	2,500			656
28.0	.07	1.00	C-2F	1,000	1829		
28.0	.08	.62	C-2F	7,500	757		657
28.0	.10	1.60	C-2F	1,000	1820		400
28.0	.17	3.00	C-2F	1,500	1864		464
28.0	.17	3.40	C-2F	500		1821	
28.0	.17	3.50	C-2F	500	313		
28.0	.20	3.00	C-2F	7,000	1873		655
36.0	.10	2.10	C-2F	1,000	1822		
37.5	.05	.65	C-2F	3,000	1828		
48.0	.10	3.20	C-2F	1,000		1823	
55.0	.05	1.10	C-5	5,000	1835		
130.0	.02	.200	C-2F	2,000	1830		

FOR ADDITIONAL LAMPS NOT LISTED IN THIS CATALOG, PLEASE CONTACT AML DIRECT.

ADVANCED **A** MICRO LITES,  
INC.

■ **T-4 MINIATURE SIZE LAMPS**

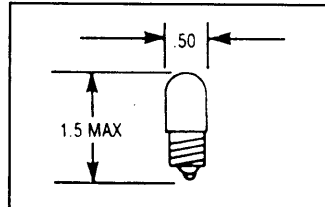

Design Volts	Design Amps	Candle Power	Filament Shape	Average Life (Hours)	CANDELABRA SCREW LAMP NUMBER
18.0	.17	2.0	C-2V	250	1480

■ **T-4½ LAMPS**

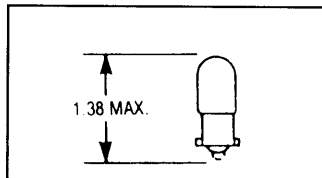

Design Volts	Design Amps	Candle Power	Filament Shape	Average Life (Hours)	MINIATURE BAYONET LAMP NUMBER
6.3	.80	3.6	C-2R	3,000	1855
28.0	.30	6.0	C-2F	500	1495

■ **T-5 LAMPS**

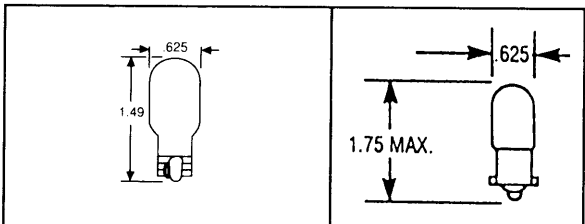

Design Volts	Design Amps	Candle Power	Filament Shape	Average Life (Hours)	WEDGE LAMP NUMBER	S.C. BAYONET LAMP NUMBER
6.0	.62	3.8	C-2R	30	909	1489
6.0	1.5	12.0	C-2R	50	908	
6.5	2.75	24.0	C-6	125		
12.8	1.4	21.0	C-2R	1,000	921	
13.0	.69	6.0	C-2F	1,000	906	
28.0	.30	6.0	C-2F	500	928	

FOR ADDITIONAL LAMPS NOT LISTED IN THIS CATALOG, PLEASE CONTACT AML DIRECT.

■ **TL-1** LENS END LAMPS

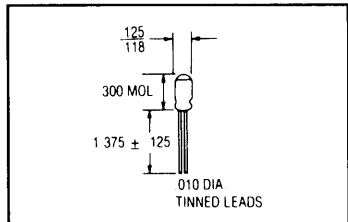

Design Volts	Design Amps	Candle Power	Filament Shape	Average Life (Hours)	WIRE TERMINAL LAMP NUMBER
5.0	.060	EFC	C-2R	25,000	1283
5.0	.115	EFC	C-2R	40,000	1415

■ **TL-1<sup>3/4</sup>**

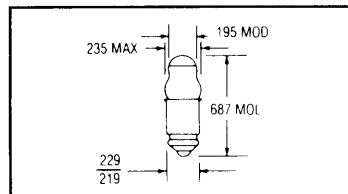

Design Volts	Design Amps	Candle Power	Filament Shape	Average Life (Hours)	MIDGET GROOVED LAMP NUMBER
2.5	.35	EFC	C-2R	10,000	253

■ **TL-3**

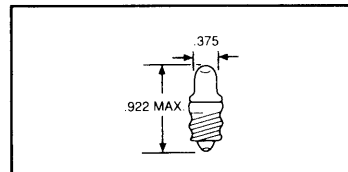

Design Volts	Design Amps	Candle Power	Filament Shape	Average Life (Hours)	MINIATURE SCREW LAMP NUMBER
1.2	.22	EFC	S-2	5	112
2.25	.25	EFC	C-6	5	222
2.33	.27	EFC	C-6	10	243

FOR ADDITIONAL LAMPS NOT LISTED IN THIS CATALOG, PLEASE CONTACT AML DIRECT.

**ADVANCED MICRO LITES, INC.**

**NEON GLOW LAMPS**

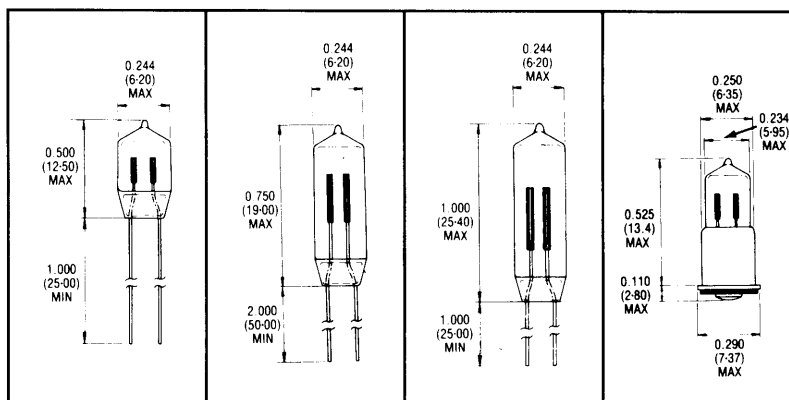

Electrical			Series Resistor (Ohms)	Life Average Hours	T-2 WIRE TERMINAL LAMP NUMBER	T-2 WIRE TERMINAL LAMP NUMBER	T-2 WIRE TERMINAL LAMP NUMBER	T-2 MIDGET FLANGED LAMP NUMBER
Circuit Voltage	Break-Down AC	Nominal Amperage						
105-125	65	0.3	220K	25,000	A1B			
105-125	95	1.2	47K	25,000	A1C			
105-125	65	0.7	100K	25,000		A9A (NE-2E) C2A (NE-2H)*		
105-125	95	1.9	30K	25,000			A1A (NE-2)	
105-125	65	0.7	100K	25,000				A1G
105-125	65	0.3	100K	25,000				A1H
105-125	75	1.2	47K	25,000				
105-125	65	0.7	100K	25,000		A2B (NE-2V)		

**NEON GLOW LAMPS**

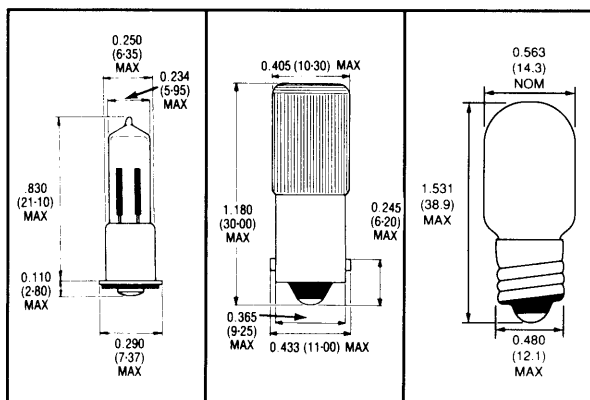

Electrical			Series Resistor (Ohms)	Life Average Hours	T-2 MIDGET FLANGED LAMP NUMBER	T-3¼ MINIATURE BAYONET LAMP NUMBER	T-4½ CANDELABRA LAMP NUMBER
Circuit Voltage	Break-Down AC	Nominal Amperage					
105-125	65	0.7	100K	25,000	C7A (NE2D)		
105-125	75	1.9	30K	25,000	C9A (NE2J)*		
105-125	65	0.3	220K	15,000		B1A (NE-51)	
105-125	95	1.2	47K	25,000		B2A (NE-51H)*	
105-125	65	2.0	30K	7,500			B7A (NE-45)

\*High brightness lamp

Caution: Bulb may shatter or circuit will be damaged if required resistor is not used.

FOR ADDITIONAL LAMPS NOT LISTED IN THIS CATALOG, PLEASE CONTACT AML DIRECT.

■ **TL-1** LENS END LAMPS

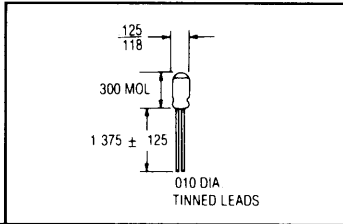

Design Volts	Design Amps	Candle Power	Filament Shape	Average Life (Hours)	WIRE TERMINAL LAMP NUMBER
5.0	.060	EFC	C-2R	25,000	1283
5.0	.115	EFC	C-2R	40,000	1415

■ **TL-1<sup>3/4</sup>**

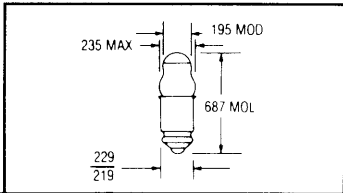

Design Volts	Design Amps	Candle Power	Filament Shape	Average Life (Hours)	MIDGET GROOVED LAMP NUMBER
2.5	.35	EFC	C-2R	10,000	253

■ **TL-3**

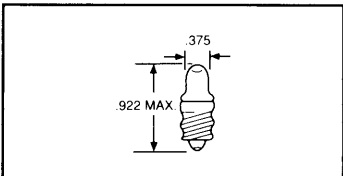

Design Volts	Design Amps	Candle Power	Filament Shape	Average Life (Hours)	MINIATURE SCREW LAMP NUMBER
1.2	.22	EFC	S-2	5	112
2.25	.25	EFC	C-6	5	222
2.33	.27	EFC	C-6	10	243

FOR ADDITIONAL LAMPS NOT LISTED IN THIS CATALOG, PLEASE CONTACT AML DIRECT.

ADVANCED MICRO LITES,  
INC.

NEON GLOW LAMPS

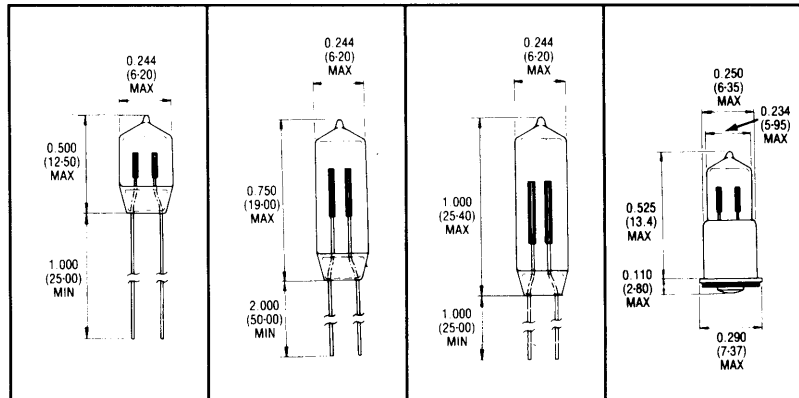

Electrical			Series Resistor (Ohms)	Life Average Hours	T-2 WIRE TERMINAL LAMP NUMBER	T-2 WIRE TERMINAL LAMP NUMBER	T-2 WIRE TERMINAL LAMP NUMBER	T-2 MIDGET FLANGED LAMP NUMBER
Circuit Voltage	Break-Down AC	Nominal Amperage						
105-125	65	0.3	220K	25,000	A1B			
105-125	95	1.2	47K	25,000	A1C			
105-125	65	0.7	100K	25,000		A9A (NE-2E) C2A (NE-2H)*		
105-125	95	1.9	30K	25,000			A1A (NE-2)	
105-125	65	0.7	100K	25,000				A1G
105-125	65	0.3	100K	25,000				A1H
105-125	75	1.2	47K	25,000				
105-125	65	0.7	100K	25,000		A2B (NE-2V)		

NEON GLOW LAMPS

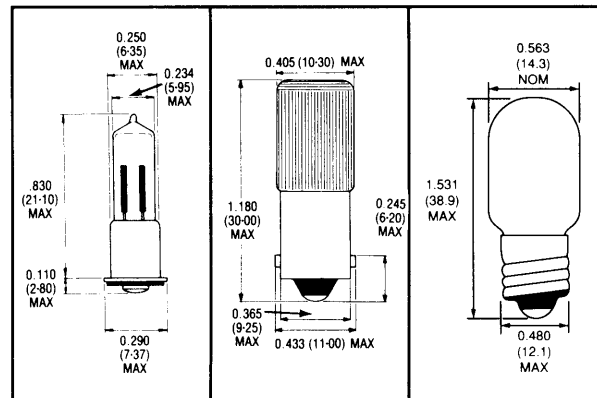

Electrical			Series Resistor (Ohms)	Life Average Hours	T-2 MIDGET FLANGED LAMP NUMBER	T-3¼ MINIATURE BAYONET LAMP NUMBER	T-4½ CANDELABRA LAMP NUMBER
Circuit Voltage	Break-Down AC	Nominal Amperage					
105-125	65	0.7	100K	25,000	C7A (NE2D)		
105-125	75	1.9	30K	25,000	C9A (NE2J)*		
105-125	65	0.3	220K	15,000		B1A (NE-51)	
105-125	95	1.2	47K	25,000		B2A (NE-51H)*	
105-125	65	2.0	30K	7,500			B7A (NE-45)

\*High brightness lamp

Caution: Bulb may shatter or circuit will be damaged if required resistor is not used.

FOR ADDITIONAL LAMPS NOT LISTED IN THIS CATALOG, PLEASE CONTACT AML DIRECT.



**ADVANCED MICRO LITES, INC.**

**FLUORESCENT LAMPS  
MINIATURE BI-PIN COOL WHITE**

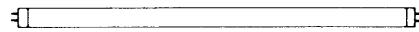

Watts	Initial Lumens Output	Average Life (Hours)	Diameter (Inches)	Length (Inches)	LAMP NUMBER
4	135	3,000	.625	6.0	F4T5/CW
6	300	3,000	.625	9.0	F6T5/CW
8	470	3,000	.625	12.0	F8T5/CW
10	490	5,000	1.0	13.0	F10T8/CW
14	650	5,000	1.0	15.0	F14T8/CW
15	850	5,000	1.0	18.0	F15T8/CW

**LEAD LAMPS**

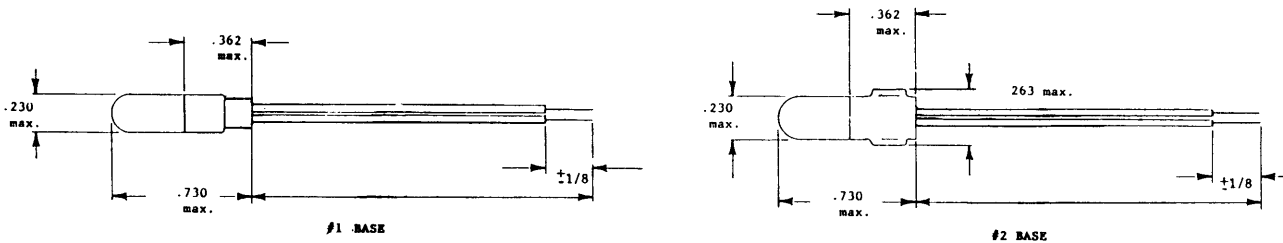

Design Volts	Design Amps	Candle Power	Filament Shape	Average Life (Hours)	LAMP NUMBER
1.35	.06	.01	C-6	500	1728
2.5	.35	.20	C-2R	10,000	2169
3.0	.015	.003	C-6	10,000	2158
5.0	.115	.15	C-2R	40,000	2203
6.0	.04	.03	C-2V	10,000	1730
6.3	.20	.40	C-2F	20,000	2181
12.0	.04	.10	C-2F	10,000	2174
14.0	.08	.30	C-2F	40,000	2182
14.0	.10	.50	C-2F	10,000	2162
18.0	.04	.15	C-2F	10,000	2102
28.0	.04	.30	C-2F	7,000	2187
28.0	.04	.34	C-2F	4,000	1764

PLEASE SPECIFY #1 or #2 BASE

LEADS ARE AVAILABLE UP TO 12" IN LENGTH

FOR ADDITIONAL LAMPS NOT LISTED IN THIS CATALOG, PLEASE CONTACT AML DIRECT.

**ADVANCED MICRO LITES, INC.**

**T-3 AIRCRAFT HALOGEN LAMPS  
FAA APPROVED**

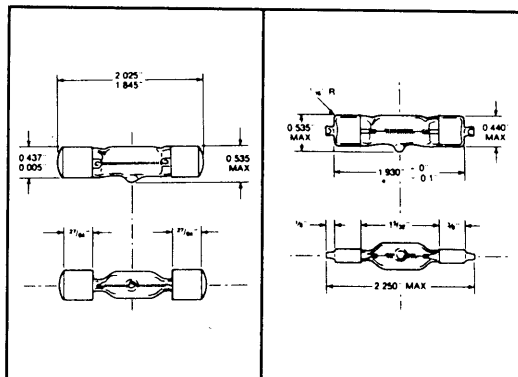

Design Volts	Design Amps	Candle Power	Filament Shape	Average Life (Hours)	LAMP NUMBER	LAMP NUMBER
10.0 28.0	10.0 3.57	130 150	C-8 CC-8	2,000 1,000	1978X	1970X

**AIRCRAFT WARNING LAMPS  
FAA APPROVED**

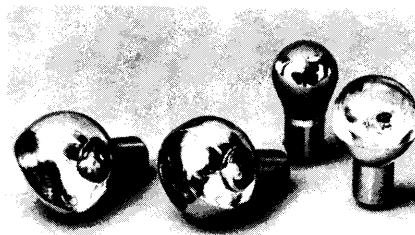

Volts	Watts	Average Life (Hours)	LAMP NUMBER	REPLACES LAMP NUMBER	MILITARY STD. LAMP NUMBER
28.0 6.2 28.0 28.0	40 40 40 40	150 150 150 150	7079 1687 684 617	A-7079B-24 16870 684	MS25338-7079 MS25338-1687
28.0 6.2	40 ± 3 40 ± 3	300 300	4174 1163	A-4174-24 11631	MS24513-4174 MS24513-1163
6.2 28.0 28.0 14.0 26.5	26 21 26 26 26	300 300 300 300 300	600 1524 7512 628	600 1524 A-7512-24 A-7512-12 628	MS25309-600 MS25309-7512 MS25309-7512

FOR ADDITIONAL LAMPS NOT LISTED IN THIS CATALOG, PLEASE CONTACT AML DIRECT.

**ADVANCED MICRO LITES, INC.**

**FLUORESCENT LAMPS  
MINIATURE BI-PIN COOL WHITE**

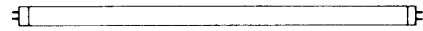

Watts	Initial Lumens Output	Average Life (Hours)	Diameter (Inches)	Length (Inches)	LAMP NUMBER
4	135	3,000	.625	6.0	F4T5/CW
6	300	3,000	.625	9.0	F6T5/CW
8	470	3,000	.625	12.0	F8T5/CW
10	490	5,000	1.0	13.0	F10T8/CW
14	650	5,000	1.0	15.0	F14T8/CW
15	850	5,000	1.0	18.0	F15T8/CW

**LEAD LAMPS**

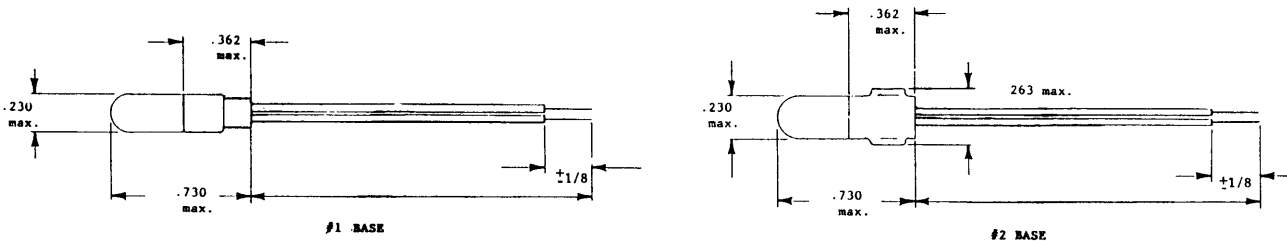

Design Volts	Design Amps	Candle Power	Filament Shape	Average Life (Hours)	LAMP NUMBER
1.35	.06	.01	C-6	500	1728
2.5	.35	.20	C-2R	10,000	2169
3.0	.015	.003	C-6	10,000	2158
5.0	.115	.15	C-2R	40,000	2203
6.0	.04	.03	C-2V	10,000	1730
6.3	.20	.40	C-2F	20,000	2181
12.0	.04	.10	C-2F	10,000	2174
14.0	.08	.30	C-2F	40,000	2182
14.0	.10	.50	C-2F	10,000	2162
18.0	.04	.15	C-2F	10,000	2102
28.0	.04	.30	C-2F	7,000	2187
28.0	.04	.34	C-2F	4,000	1764

PLEASE SPECIFY #1 or #2 BASE  
LEADS ARE AVAILABLE UP TO 12" IN LENGTH

FOR ADDITIONAL LAMPS NOT LISTED IN THIS CATALOG, PLEASE CONTACT AML DIRECT.

**T-3 AIRCRAFT HALOGEN LAMPS  
FAA APPROVED**

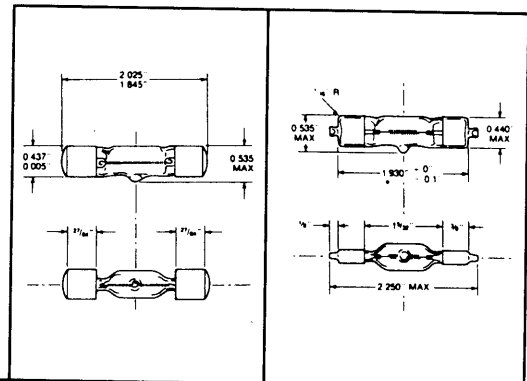

Design Volts	Design Amps	Candle Power	Filament Shape	Average Life (Hours)	LAMP NUMBER	LAMP NUMBER
10.0 28.0	10.0 3.57	130 150	C-8 CC-8	2,000 1,000	1978X	1970X

**AIRCRAFT WARNING LAMPS  
FAA APPROVED**

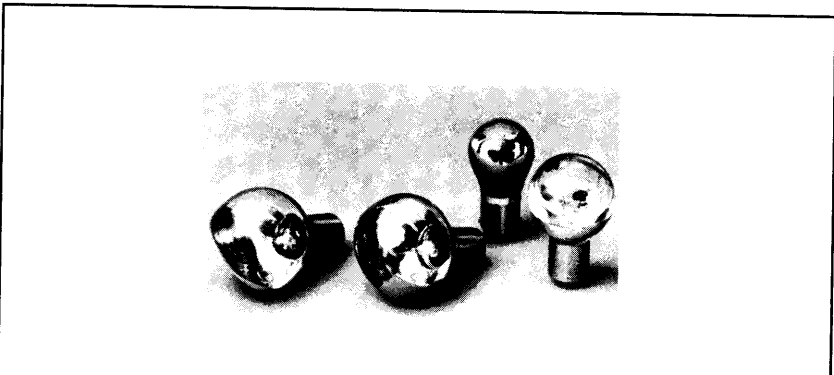

Volts	Watts	Average Life (Hours)	LAMP NUMBER	REPLACES LAMP NUMBER	MILITARY STD. LAMP NUMBER
28.0 6.2 28.0 28.0	40 40 40 40	150 150 150 150	7079 1687 684 617	A-7079B-24 16870 684	MS25338-7079 MS25338-1687
28.0 6.2	40 ± 3 40 ± 3	300 300	4174 1163	A-4174-24 11631	MS24513-4174 MS24513-1163
6.2 28.0 28.0 14.0 26.5	26 21 26 26 26	300 300 300 300 300	600 1524 7512 628	600 1524 A-7512-24 A-7512-12 628	MS25309-600 MS25309-7512 MS25309-7512

FOR ADDITIONAL LAMPS NOT LISTED IN THIS CATALOG, PLEASE CONTACT AML DIRECT.

MS NO.	LAMP NO.	MS NO.	LAMP NO.	MS NO.	LAMP NO.
3338-6839	6839	15584-8	1692	25237-327R	327 Red
15536-1	46	15584-13	1158	25237-328	328
15536-2	41	15584-14	1176	25237-328-10	328AS10
15536-3	42	15584-15	306	25237-328R	328 Red
15536-4	40	15584-16	308	25237-328R15	328 Red15
15559-1	1323	15584-17	308 Red	25237-338	338
15564-1	1184	15588-3	F8T5/CW	25237-368	368
15564-2	1134	15609-1	48B (Tel)	25237-381	381
15564-4	1144	15609-3	12A (Tel)	25237-385AS15	385AS15
15564-5	1000	15609-5	60A (Tel)	25237-387	387
15564-6	1196	15609-6	48C (Tel)	25237-8918	8918
15565-1	1133	15609-7	12C (Tel)	25238-301	301
15565-2	1183	15609-8	24D (Tel)	27571-6809AS15	6809AS15
15565-3	1143	15609-10	6C (Tel)	35478-87	87
15565-4	1195	15611-1	13	35478-93	93
15567-1	6S6DC (120V)	15611-2	365	35478-305	305
15569-1	64	15611-3	14	35478-307	307
15569-2	64 Red	15611-4	131	35478-307R	307 Red
15569-3	82	15612-1	1768	35478-315	315
15569-4	90	15612-2	335	35478-1073	1073
15569-6	68	15612-3	1769	35478-1129	1129
15569-7	1252	15612-4	1767	35478-1141	1141
15569-8	304	15613-2	302	35478-1680	1680
15570-63	63	15669-8	304	35478-1683	1683
15570-63R	63 Red	16123-1	10C7/DC	35478-1691	1691
15570-67	67	24367-680	680	35478-2232	2232
15570-81	81	24367-683AS15	683AS15	35478-2233	2233
15570-89	89	24367-713	713	35480-1	1383
15570-303	303	24367-713AS15	713AS15	35480-2	1385
15570-303R	303 Red	24367-715	715	35481-1	1154
15570-623	623	24367-715AS15	715AS15	35481-2	1016
15570-1251	1251	24515-682	682	51608-2	329
15571-1	44	24515-682AS15	682AS15	51608-3	325
15571-2	47	24515-685	685	51608-4	673
15571-5	1809	24515-685AS15	685AS15	51608-6	8644
15571-7	44 Red	24515-714	714	51608-7	8635
15571-8	1815	24515-714AS15	714AS15	90451-6832	6832AS15
15571-9	1810	24515-718	718	90451-7152	7152AS15
15571-11	45	24515-718AS15	718AS15	90452-6803	6803AS15
15572-1	55	25069-1495	1495	90452-6833	6833AS15
15572-2	55 Red	25231-313	313	90452-7133	7133AS15
15573-1	51	25231-313R	313 Red	90452-7153	7153AS15
15573-2	51 Red	25231-1819	1819		
15573-3	356	25231-1819R	1819 Red		
15573-6	354	25231-1829	1829		
15573-4	53	25231-1873	1873		
15574-1	15T7C (120V)	25235-311	311		
15579-1	6S6 (115V)	25235-311R	311 Red		
15579-2	6S6 (135V)	25236-323	323		
15579-3	10S6/10 (250V)	25236-323R	323 Red		
15579-5	6S6 (155V)	25236-8623	8623		
15579-7	3S6/5 (125V)	25236-8623R	8623 Red		
15584-1	88	25236-8639	8639		
15584-2	94	25236-8639R	8639 Red		
15584-3	1130	25237-327	327		
15584-4	1142	25237-327-15	327-15		
			327AS15		

**ADVANCED MICRO LITES, INC.**

LAMP NUMBER	PAGE	LAMP NUMBER	PAGE	LAMP NUMBER	PAGE	LAMP NUMBER	PAGE
A1A	19	19	5	155MB	14	378	12
A1B	19	24B	13	155PSB	14	379	12
A1C	19	24CSB	14	158	15	380	11
A1G	19	24E	13	159	15	381	11
A1H	19	24ESB	14	161	15	382	11
A2B	19	24MB	14	168	15	385	11
A9A	19	24PSB	14	194	15	386	12
B1A	19	24X	13	199	7	387	11
B2A	19	27	5	211	NL*	388	12
B7A	19	28ESB	14	219	5	394	11
C2A	19	28MB	14	222	18	397	12
C7A	19	28PSB	14	238	15	398	12
C9A	19	32	9	239	15	399	12
PR-2	4	35A	13	243	18	400	16
PR-3	4	37	12	245	5	407	5
PR-4	4	40	15	253	18	425	5
PR-6	4	41	15	256	15	428	5
PR-7	4	42	15	257	5	447	15
PR-12	4	43	15	259	15	447	15
PR-13	4	43	15	268	11	455	5
PR-13	4	44	15	276	12	456	5
PR-15	4	45	15	293	5	459	11
PR-16	4	46	15	301	6	464	16
PR-18	4	47	15	302	6	502	5
PR-20	4	48	15	302	6	502	5
PR-30	4	48	15	303	6	503	5
PR-30	4	48ESB	14	304	6	515	10
PR-31	4	48MB	14	305	7	555	15
PR-32	4	48PSB	14	306	7	585	16
2	9	49	15	307	7	595	7
3S6/120	7	50	5	308	7	605	5
6	7	51	5	309	8	623	6
6PSB	14	51A	13	311	8	624	6
6S6/6	7	52	5	312	8	628	6
6S6/12	7	53	5	313	16	628	6
6S6/24	7	55	5	315	7	634	10
6S6/30	7	55C	5	323	10	655	16
6S6/48	7	57	5	324	10	656	16
6S6/60	7	60MB	14	325	10	657	16
6S6/120	7	60PSB	14	327	11	658	15
6S6/135	7	63	6	328	11	673	10
6S6/145	7	64	6	330	11	674	NL*
6S6/155	7	67	6	331	11	678	NL*
6S6/250	7	68	6	333	4	680	9
6S6DC/120	7	73	12	334	12	682	9
6S6DC/135	7	74	12	335	12	683	9
6S6DC/145	7	81	6	335LSV	12	685	9
6S6DC/155	7	82	6	336	12	713	9
6S6DC/250	7	85	12	337	12	714	9
7C7	7	86	12	338	11	715	9
10	5	87	7	342	12	718	9
10ESB	14	88	7	344	11	737	10
10S6/120	7	89	6	345	11	755	15
10S6/250	7	90	6	346	12	756	15
10S6DC/250	7	90MB	14	349	11	757	16
12	5	93	7	350	11	906	17
12A	13	94	7	356	5	908	17
12ESB	14	97	6	363	5	908	17
12MB	14	112	18	367	11	909	17
12PSB	14	120MB	14	368	11	921	17
13	5	120PSB	14	370	11	928	17
14	5	123	5	373	12	1003	4
18A	13	130	5	375	11	1004	4
18B	13	131	5	376	11	1034	8
				377	11	1047	6
						1062	6

FOR ADDITIONAL LAMPS NOT LISTED IN THIS CATALOG, PLEASE CONTACT AML DIRECT.

**ADVANCED MICRO LITES,  
INC.**

LAMP NUMBER	PAGE	LAMP NUMBER	PAGE	LAMP NUMBER	PAGE	LAMP NUMBER	PAGE
1073	7	1818	16	7133	9	8640	10
1076	7	1819	16	7152	9	8645	10
1129	7	1820	16	7153	9	8666	9
1130	7	1821	16	7203	9	8918	11
1133	6	1822	16	7210	9	<b>AIRCRAFT</b>	
1141	7	1823	16	7216	4	<b>WARNING</b>	
1142	7	1828	16	7219	9	600	21
1156	7	1829	16	7220	9	617	21
1157	8	1830	16	7234	9	628	21
1176	8	1835	16	7235	9	684	21
1195	6	1843	16	7240	9	1163	21
1196	6	1847	15	7241	9	1524	21
1203	7	1850	15	7263	9	1687	21
1204	7	1855	17	7265	9	4174	21
1228	7	1864	16	7327	11	7079	21
1251	6	1866	15	7328	11	7512	21
1252	6	1869	11	7330	11	<b>BELL LILLIPUT</b>	
1283	18	1873	16	7333	11	<b>TELEPHONE</b>	
1295	7	1888	15	7341	11	<b>SWITCHBOARD</b>	
1309	4	1889	15	7349	11	T4.6 12/50	13
1315	6	1891	15	7349	11	T4.6 24/20	13
1317	4	1892	16	7354	12	T4.6 24/50	13
1383	6	1893	15	7355	12	T4.6 30/40	13
1385	6	1895	5	7361	11	T5.5 24/20	13
1408	15	1970X	21	7362	11	T5.5 24/30	13
1415	18	1978X	21	7367	11	T5.5 24/50	13
1445	5	2022	9	7370	11	T5.5 30/40	13
1446	5	2102	11,20	7371	11	<b>FLUORESCENT</b>	
1447	5	2112	11	7373	11	F4T5/CW	20
1449	5	2114	10	7374	11	F6T5/CW	20
1450	5	2158	11,20	7376	11	F8T5/CW	20
1460	8	2162	11,20	7377	11	F10T8/CW	20
1460X	8	2169	11,20	7380	11	F14T8/CW	20
1480	17	2174	11,20	7381	11	F15T8/CW	20
1487	15	2176	11	7382	11	<b>FUSE</b>	
1488	15	2180	11	7387	11	GF550	13
1489	17	2181	11,20	7515	10	GF670	13
1490	15	2182	11,20	7632	10	GF740	13
1493	7	2185	11	7646	10	<b>INDICATOR</b>	
1495	17	2187	11,20	7683	9	<b>LIGHT WIRED</b>	
1619	7	2200	11	7714	9	1728	20
1630	8	2203	11,20	7715	9	1730	20
1651	7	2232	7	7732	9	1764	20
1662	8	2233	7	7839	9	2102	20
1665	7	3011	8	7876	11	2158	20
1680	7	3150	11	8097	8	2162	20
1683	7	3156	8	8098	9	2169	20
1691	7	3157	8	8099	9	2174	20
1692	7	6022	9	8111	9	2181	20
1705	11	6150	9	8112	9	2182	20
1728	11,20	6152	9	8189	10	2187	20
1730	11,20	6153	9	8190	10	2203	20
1738	11	6180	9	8191	10		
1739	11	6802	9	8192	10		
1764	11,20	6809	9	8193	10		
1768	12	6832	9	8194	10		
1769	12	6833	9	8270	9		
1775	12	6838	9	8362	12		
1784	11	6839	9	8552	10		
1810	15	6848	11	8623	10		
1813	16	7001	11	8627	10		
1815	15	7009	9	8628	10		
1816	15	7112	9	8637	10		
		7132	9				

FOR ADDITIONAL LAMPS NOT LISTED IN THIS CATALOG, PLEASE CONTACT AML DIRECT.