

SAFRAN ELECTRONICS & DEFENSE AVIONICS USA LLC

SERIES 10

 SAFRAN

## SERIES 10 FEATURES

### FEATURING A FOUR LAMP DESIGN, POSITIVE HARD MOUNTING SLEEVE, INDIVIDUAL LAMP COLOR CONTROL, UP TO 4-WAY SPLIT DISPLAY FACE.

The Series **10E** Twist-Lite® is a 4-lamp indicator unit with a modular design that permits it to be used as a lighted pushbutton switch or as a word indicator light for design compatibility. Inclusion of a magnetic holding coil for numerous electrical interlock, lock-in, and lock-out circuits gives the switch light complete capability. The 4-lamp design combined with a choice of divided screens offers many display possibilities. Depression of the front lens actuates the switch module which is available in momentary or alternate action in snap-on assemblies. Legends may be reverse engraved on the front lens at the factory for uniform readability and long wear. The special slip-on mounting sleeve provides a positive hard mount particularly useful in equipment designed for extreme measures of shock and vibration. Flush mounting is easily achieved in horizontal or vertical rows, as well as matrix configurations.



The Series **10H** Twist-lite is basically the same as the Series **10E**, except it has been qualified to meet the requirements of **MIL-PRF-22885**.

### EASY FRONT OF PANEL RELAMPING

Lamp replacement is accomplished from the panel front without the use of tools and may easily be done without fear of accidental switch actuation. Simply **PULL, TWIST, and REMOVE** for complete access to the lamps.

### POSITIVE INDEXING

During relamping, the front end assembly remains connected to the unit's housing by two sides. This important feature precludes the possibility of inadvertently transposing the front end assembly with adjacent units. (Series **10E** only).

For positive indexing on Series 10H military version, order by part number **10H7**.

## HOW TO USE THIS CATALOG

The pages of this catalog describe the component parts that make up a Series 10 Switch-Lite or Indicator-Lite unit. To define the units you want, simply select the code that identifies your choice of each required element. The selected codes, when written together become the part number you will use to order the units. A typical part number is illustrated as below.

10E1	O	A1C2	F2	J3	L(AABB)	N2	R1,V16	ON/OFF
SERIES NUMBER. PAGES 4 & 5	VARIATIONS OF BASIC UNIT. PAGES 14 & 15	BASIC UNIT. PAGE 7	SWITCH ASSEMBLY. PAGES 8 & 9	LAMPS. PAGE 10	COLORLED BULB FILTERS. PAGES 10 & 11	DISPLAY SCREENS. PAGE 11	LEGEND CONFIGURATION. PAGES 12 & 13	LEGEND WORDING. PAGES 12 & 13

A sample part number appears at the top of each of the following pages emphasizing the code you are selecting from that page.

The exploded view below illustrates the elements of a typical Series 10 Switch-Lite or Indicator-Lite unit and the pages of this catalog that describe each element.

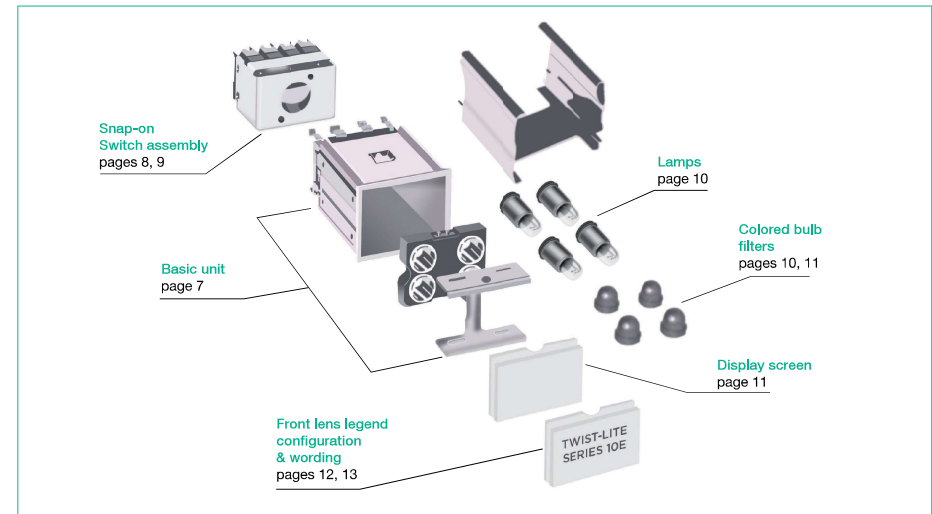

## SERIES NUMBER - 10E

### 10EA1C2F2J3L(AABB)N2R1.V16 ON/OFF

#### COMPLETED UNIT OUTLINE DIMENSIONS

The first three digits of the part number are the Series Number, which identify the unit. In this case the Series Number is «10E», which identifies it as a 4-lamp indicator unit with snap-on switch capability. The unit's physical size, panel cutout dimension requirements, and mounting arrangement capabilities are described and illustrated on the following pages.

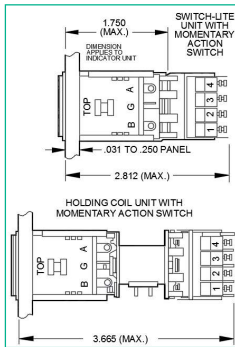

#### NOTES :

1. Terminals will accept two #20 (AWG) wire leads.
2. Holding Coil Power Requirements: 3 watts (MAX).
3. For mounting on panels 0.000-0.150 inch thick, the notch on the side of the mounting sleeve should be toward the front of the unit. For mounting on panels 0.150-0.280 inch thick, the sleeve should be turned around so that the notch is toward the back of the unit.
4. When the mounting unit is 90° from normal, the top of the unit shall appear on right side as viewed from the panel front.

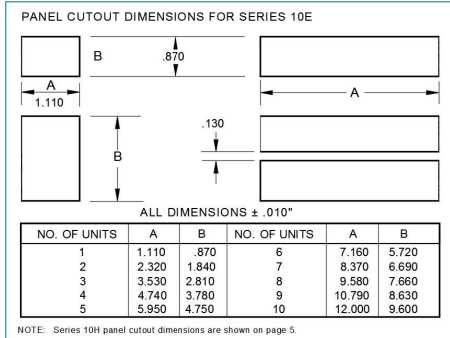

NOTE: Series 10H panel cutout dimensions are shown on page 5.

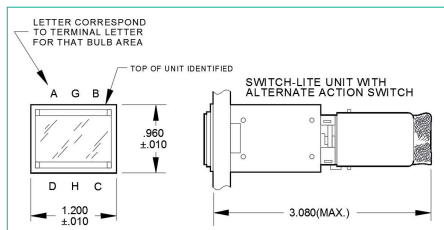

## SERIES NUMBER - 10H

### 10HA1C3F2J3L(GGRR)N3R1.V16 ON/OFF

#### COMPLETED UNIT OUTLINE DIMENSIONS

The Series 10H is basically the same as the Series 10E, except it has been qualified to meet the requirements of MIL-PRF-22885. Its outline dimensions are slightly different and are shown on the following diagrams. The following is a cross reference of the MIL-PRF-22885 part numbers to the Safran Series 10H part numbers. Part numbers shown are for units without lamps or color filters. When color filters are required, add color symbols within ( ). For lamp ordering information see page 12.

MILITARY PART NUMBER	SAFRAN PART NUMBER	TYPE
M22885/9-01 (XXXX)	10HA1C1FILC ( )N1R1	SWITCH TYPE
M22885/9-02 (XXXX)	10HA1C1F2LC ( )N1R1	
M22885/9-03 (XXXX)	10HA1C1F3LC ( )N1R1	
M22885/9-04 (XXXX)	10HA1C1F4LC ( )N1R1	
M22885/9-05 (XXXX)		
M22885/9-06 (XXXX)		
M22885/9-07 (XXXX)		
M22885/9-08 (XXXX)		
M22885/9-09 (XXXX)	10HA1C1FILC ( )N2R1	
M22885/9-10 (XXXX)	10HA1C1F2LC ( )N2R1	
M22885/9-11 (XXXX)	10HA1C1F3LC ( )N2R1	
M22885/9-12 (XXXX)	10HA1C1F4LC ( )N2R1	
M22885/9-13 (XXXX)	10HA1C2FILC ( )N2R1	
M22885/9-14 (XXXX)	10HA1C2F2LC ( )N2R1	
M22885/9-15 (XXXX)	10HA1C2F3LC ( )N2R1	
M22885/9-16 (XXXX)	10HA1C2F4LC ( )N2R1	
M22885/9-17 (XXXX)	10HA1C1FILC ( )N3R1	
M22885/9-18 (XXXX)	10HA1C1F2LC ( )N3R1	
M22885/9-19 (XXXX)	10HA1C1F3LC ( )N3R1	
M22885/9-20 (XXXX)	10HA1C1F4LC ( )N3R1	
M22885/9-21 (XXXX)	10HA1C3FILC ( )N3R1	
M22885/9-22 (XXXX)	10HA1C3F2LC ( )N3R1	
M22885/9-23 (XXXX)	10HA1C3F3LC ( )N3R1	
M22885/9-24 (XXXX)	10HA1C3F4LC ( )N3R1	
M22885/9-25 (XXXX)	10HA1C3FILC ( )N1R1	
M22885/9-26 (XXXX)	10HA1C3F2LC ( )N1R1	
M22885/9-27 (XXXX)	10HA1C3F3LC ( )N1R1	
M22885/9-28 (XXXX)	10HA1C3F4LC ( )N1R1	
M22885/10-01 (XXXX)	10HA2C1LC ( )N1R1	INDICATOR TYPE
M22885/10-03 (XXXX)	10HA2C1LC ( )N2R1	
M22885/10-04 (XXXX)	10HA2C2LC ( )N2R1	
M22885/10-05 (XXXX)	10HA2C1LC ( )N3R1	
M22885/10-06 (XXXX)	10HA2C3LC ( )N3R1	
M22885/10-07 (XXXX)	10HA2C3LC ( )N1R1	

#### NOTES :

1. Terminals will accept two #20 (AWG) wire leads.
2. Holding Coil Power Requirements: 3 watts (MAX).
3. For mounting on panels 0.000-0.150 inch thick, the notch on the side of the mounting sleeve should be toward the front of the unit. For mounting on panels 0.150-0.280 inch thick, the sleeve should be turned around so that the notch is toward the back of the unit.
4. When the mounting unit is 90° from normal, the top of the unit shall appear on right side as viewed from the panel front.

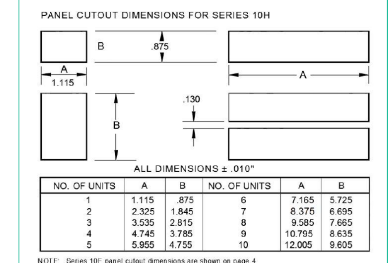
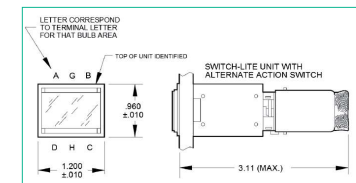
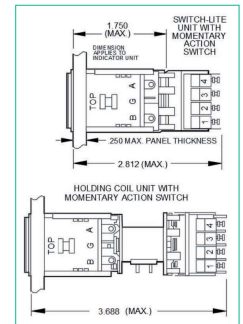

NOTE: Series 10E panel cutout dimensions are shown on page 4.

Additional mil-spec listings available on request.

## MOUNTING 10E & 10H

### EASY PANEL MOUNTING

The unit is easily mounted to the panel by installing it from the front of the panel and sliding the mounting sleeve over the rear of the unit. The two captive mounting screws - accessible from the panel front when the front end assembly is removed - are then tightened with a standard screwdriver, pulling the sleeve tight against the back of the panel.

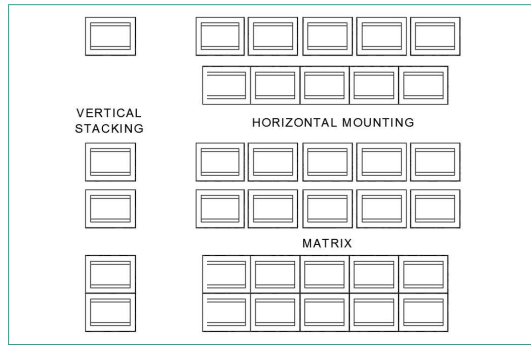

### UNLIMITED MOUNTING ARRANGEMENTS

Designers are afforded infinite flexibility in panel layout. Units may be mounted individually with no restrictions as to the space allowed between associated equipments. Vertical and horizontal rows can be mounted in elongated cutouts rather than in individual cutouts. Units may be removed or installed without disturbing adjacent units. Matrix mountings are available.

### SPACER BARRIERS

These spacer barriers provide additional separation between units, and are available in several different colors. Styles for vertical stacks or horizontal rows are offered. Barriers are ordered separately from unit.

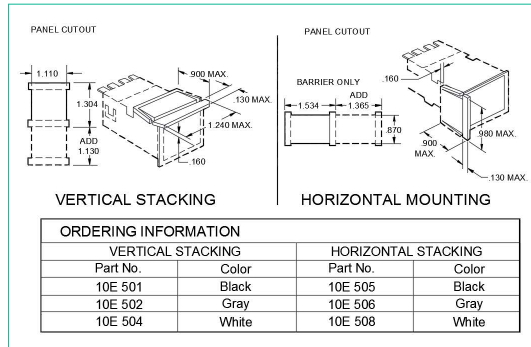

## BASIC UNITS - SERIES 10

### 10EA1C2F2J3L(AABB)N2R1,V16 ON/OFF & 10HA1C2F2J3L(GGRR)N3R1,V16 ON/OFF

### SWITCH-LITE UNITS

Combined capability of both indication and switching are available in this unit. Depression of the front lens actuates the switch contacts, which are completely isolated from the lamp circuit, allowing independent control of illumination. Switches are available in momentary or alternate action, 2PDT or 4PDT.

### INDICATOR UNITS

Applications requiring indication only are easily accomplished by the indicator unit, which has a limiting clip installed to prevent the front lens from being depressed. This unit is readily converted to a Switch-Lite by removal of the clip and installation of the desired switch assembly.

### HOLDING COIL UNITS

Numerous electrical interlock, lock-in, and lock-out circuits are made possible by including a magnetic holding coil with the Switch-Lite unit. Depressing the front lens after the coil has been energized causes the switch contacts to remain actuated until the coil voltage is removed.

### INTERNALLY BUSSED LAMP CIRCUITS REDUCE SOLDERING, SAVE INSTALLATION TIME AND COST

The various lamp circuits for versatile display use are internally bussed to eliminate several soldering operations and provide additional flexibility in design.

Typical lamp circuits are shown in the following table.

### Series 10E

LAMP CIRCUIT	SWITCH-LITE UNIT	INDICATOR UNIT	HOLDING COIL UNIT		
			6 VOLT	12 VOLT	28 VOLT
1 COMMON GROUND SEPARATE INPUT	A1C1	A2C1	A4C1	A5C1	A3C1
2 HORIZONTAL SPLIT GRD SEPARATE INPUT	A1C2	A2C2	A4C2	A5C2	A3C2
3 VERTICAL SPLIT GRD SEPARATE INPUT	A1C3	A2C3	A4C3	A5C3	A3C3
4 SEPARATE GROUND SEPARATE INPUT	A1C4	A2C4	A4C4	A5C4	A3C4
5 COMMON GROUND COMMON INPUT	A1C5	A2C5	A4C5	A5C5	A3C5
6 COMMON GROUND HORIZONTAL SPLIT INPUT	A1C6	A2C6	A4C6	A5C6	A3C6
7 COMMON GROUND VERTICAL SPLIT INPUT	A1C7	A2C7	A4C7	A5C7	A3C7
8 HORIZONTAL SPLIT GRD HORIZONTAL SPLIT INPUT	A1C8	A2C8	A4C8	A5C8	A3C8
9 VERTICAL SPLIT GRD VERTICAL SPLIT INPUT	A1C9	A2C9	A4C9	A5C9	A3C9

### Series 10H

LAMP CIRCUIT	SWITCH-LITE UNIT	INDICATOR UNIT	HOLDING COIL UNIT		
			6 VOLT	12 VOLT	28 VOLT
1 COMMON GROUND SEPARATE INPUT	A1C1	A2C1	A4C1	A5C1	A3C1
2 VERTICAL SPLIT GRD SEPARATE INPUT	A1C2	A2C2	A4C2	A5C2	A3C2
3 HORIZONTAL SPLIT GRD SEPARATE INPUT	A1C3	A2C3	A4C3	A5C3	A3C3
4 SEPARATE GROUND SEPARATE INPUT	A1C4	A2C4	A4C4	A5C4	A3C4
5 COMMON GROUND COMMON INPUT	A1C5	A2C5	A4C5	A5C5	A3C5
6 COMMON GROUND HORIZONTAL SPLIT INPUT	A1C6	A2C6	A4C6	A5C6	A3C6
7 COMMON GROUND VERTICAL SPLIT INPUT	A1C7	A2C7	A4C7	A5C7	A3C7
8 HORIZONTAL SPLIT GRD HORIZONTAL SPLIT INPUT	A1C8	A2C8	A4C8	A5C8	A3C8
9 VERTICAL SPLIT GRD VERTICAL SPLIT INPUT	A1C9	A2C9	A4C9	A5C9	A3C9

## SWITCH ASSEMBLIES – SERIES 10E

10EA1C2F2J3L(AABB)N2R1,V16 ON/OFF

### SNAP-ACTION CONTACTS

Switch assemblies feature a positive snap-action design that assures instantaneous contact transfer, which is perceptible to the touch at the instant of actuation. The force required to switch is sufficient to prevent accidental switching.

### BIFURCATED CONTACTS

Bifurcated contacts multiply reliability up to 40 times compared with single-point contacts. This feature uses two parallel contact points, either of which can handle the rated load, insuring against effects of particulate contamination. Offers more reliable dry circuit switching.

### SWITCH RATINGS

#### SNAP-ACTION CONTACTS

**SILVER:** Rated for 5 amps at 125 or 250 volts A.C. The 30-volt D.C. rating is: Inductive, 3 amps; Resistive, 5 amps.

**GOLD:** The 30-volt D.C. rating is: Inductive, ½ amp, Resistive 1 amp.

#### BIFURCATED CONTACTS

**GOLD:** The 30-volt D.C. rating is: Inductive ½ amp, Resistive 1 amp.

Switch assembly ordering code for series 10E only

BASIC UNIT TYPE	MOMENTARY ACTION		ALTERNATE ACTION	
	2PDT	4PDT	2PDT	4PDT
Snap-action silver	F1	F2	F3	F4
Snap-action gold	F10	F11	F12	F13
Sliding-bifurcated gold	F38	F39	F40	F41

**NOTE:** For Series 10H Switch Assembly ordering code see Page 9.

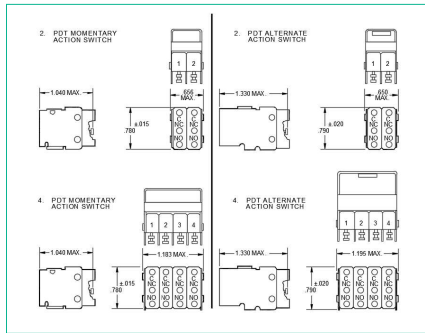

## SWITCH ASSEMBLIES – SERIES 10H

10HA1C3F2J3L(GGRR)N3R1,V16 ON/OFF

### SNAP-ACTION CONTACTS

Switch assemblies feature a positive snap-action design that assures instantaneous contact transfer, which is perceptible to the touch at the instant of actuation. The force required to switch is sufficient to prevent accidental switching.

### SWITCH RATINGS (AT SEA LEVEL)

#### SNAP-ACTION CONTACTS

**SILVER:** Rated for 5 amps at 115 volts A.C. for both inductive and resistive loads. The 28-volt D.C. rating is: Inductive, 3 amps; Resistive, 5 amps.

SWITCH CONTACTS	MOMENTARY ACTION		ALTERNATE ACTION	
	2PDT	4PDT	2PDT	4PDT
SNAP-ACTION SILVER	F1	F2	F3	F4
MILITARY PART NUMBER	M22885/11-01	M22885/11-02	M22885/11-03	M22885/11-04

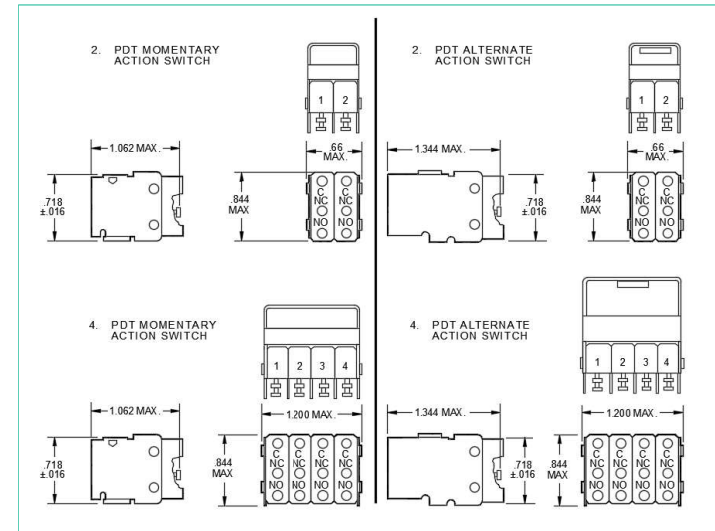

## LAMPS & COLORED LAMP FILTERS SERIES 10E OR 10H

### 10EA1C2F2J3L(AABB)N2R1.V16 ON/OFF

#### LAMP TYPES

T-1½ midget flange base incandescent lamps are available in 6, 12, and 28 volts. A special neon lamp with or without a built-in current limiting resistor is also available for 115VAC applications, but is only recommended for use with red or amber colors. See the accompanying table for part number ordering codes.

**Note:** Neon lamps without built-in resistor require external current limiting resistance.

When ordering as a separate item, precede the above code number by basic «10E» or «10H» to make part number.

#### COLORED LAMP FILTERS

Individual lamp color control is provided by silicone rubber filters, which fit over each lamp socket. These high efficiency filters are available in amber, blue, green, red, white, and yellow. The chromaticity of each color has been carefully selected to insure maximum operator response and discernibility between colors.

#### PROJECTED COLOR

Prior to illumination the black letters engraved on the clear front lens are easily read against the white translucent display screen background. When energized, the background illuminates in color. Projected color also provides for full display, two color indication as well as two color split screen indications.

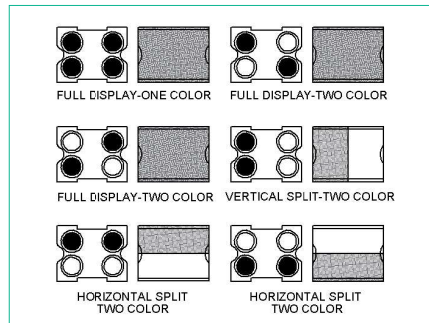

6 VOLT LAMPS	12 VOLT LAMPS	28 VOLT LAMPS	115 VAC NEON LAMPS WITH RESISTORS	115 VAC NEON LAMPS WITHOUT RESISTORS
J1	J2	J3	J4	J10

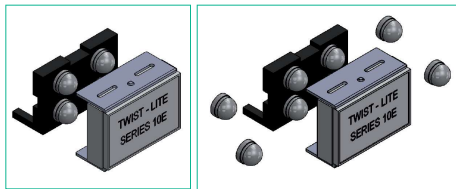

#### COLORED LAMP FILTER ORDERING CODES

All colors apply to Series 10E. All colors, except amber (A), apply to Series 10H, military version.

COLOR	CODE NUMBER	MILITARY PART NUMBER
AMBER	L(A)	
BLUE	L(B)	M22885/12-001
GREEN	L(G)	M22885/12-002
RED	L(R)	M22885/12-003
WHITE (see NOTE 2)	L(W)	M22885/12-004
YELLOW	L(Y)	M22885/12-005

#### NOTES:

1. Where more than one color is desired within the same unit, denote by including within the parenthesis, ( ), all colors desired. Priority for actual location in the unit when viewed from the front of the panel is: upper left, upper right, lower left, lower right.

Where two colors are indicated, and the display screen callout is for a full display, the first color will be upper left, lower right and the second color will be upper right, lower left.

2. White color is produced by a light blue bulb filter.

## DISPLAY SCREENS FOR SERIES 10

### 10EA1C2F2J3L(AABB)N2R1.V16 ON/OFF or 10HA1C3F2J3L(GRRR)N3R1.V16 ON/OFF

The advantages of individual lamp color control and projected color is further enhanced by the display screen which is available in all possible display arrangements. This combined capability provides an unlimited number of indication arrangements.

#### WHITE TRANSLUCENT DISPLAY SCREENS

The translucent display screen evenly diffuses the light across the entire front lens. Variations in background color are effected through the use of color lamp filters. Where horizontally or vertically-split displays are desired, color lamp filters can provide a different color in each part of the display with no light leakage between displays because of a unique divider arrangement. Screen appears white until illuminated and then appears in color.

#### Series 10E

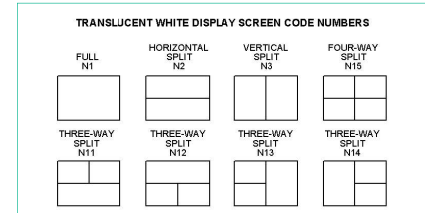

#### Series 10H

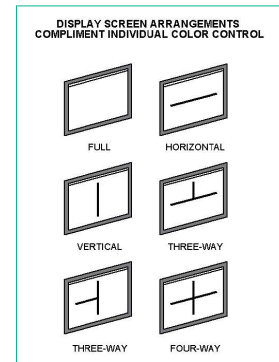
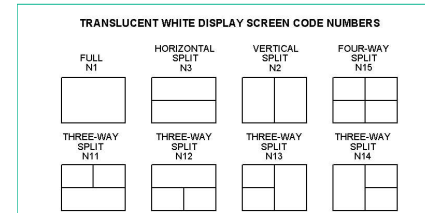

#### COLORED DISPLAY SCREENS

The normally translucent white display screens are also available in translucent colors. All standard colors are available in any combination of colors for split display. Colored lamp filters are not required when using colored display screens. Screen appears in color when not illuminated and glows brightly in color when illuminated.

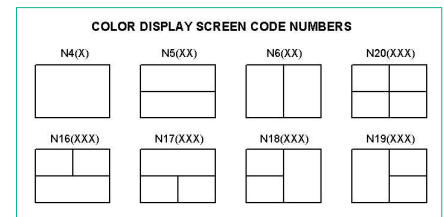

# LEGENDS - SERIES 10E & 10H

## 10EA1C2F2J3L(AABB)N2R1,V16 ON/OFF

### TRANSMITTED COLOR (SLAB FILTERS)

The front lens with required engraving is ordered by following the callout «R1V» with the engraving configuration number as selected from those below.

After this, the actual wording is added, using commas between rows of lettering and a straight vertical line between splits. Priority for segments of split displays when viewed from the front of the panel is upper left, upper right, lower left, lower right. Examples are shown at the right.

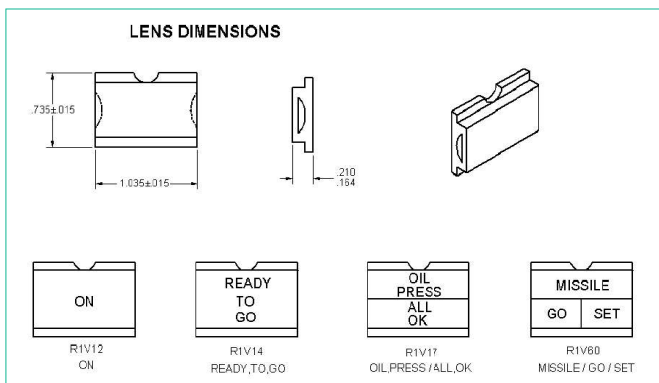

### BLANK FRONT LENS

When a non-engraved front lens is required, the code number «R1» is used, eliminating the remaining part of the engraved front lens callout.

### SEPARATE ENGRAVED LENS

Where separate engraved lenses are required, precede the complete engraved front lens callout with the basic «10E» or «10H».

### ENGRAVING SPECIFICATIONS

Front lens is reverse engraved 0.120 inch high with 0.020 inch stroke and filled with a special black filler. The engraving is done on the back face of the lens for appearance and long life.

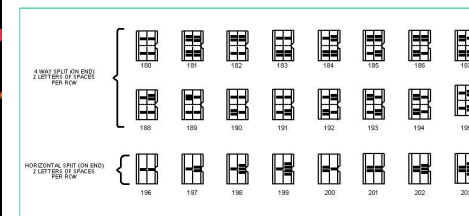
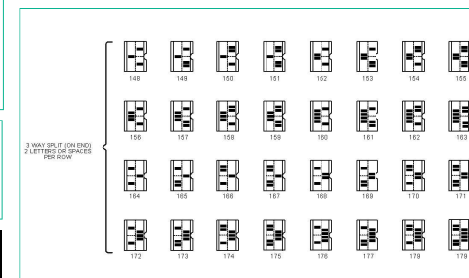
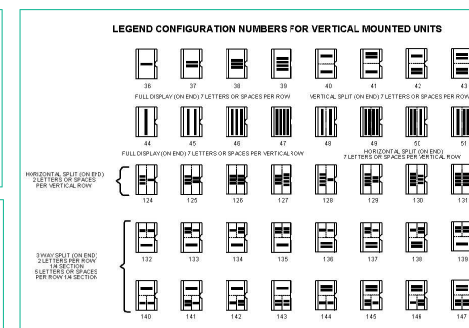
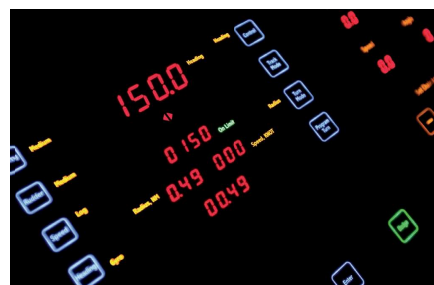
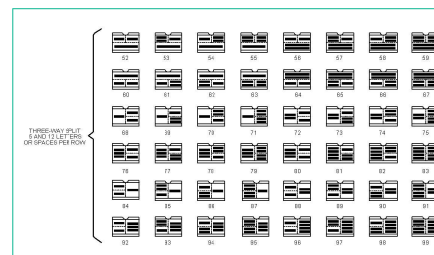
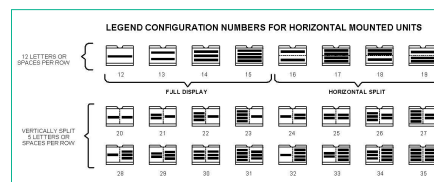



## FOUR COLOR DISPLAY FOR SERIES 10E OR 10H

### 10E10A1C1F1J3L1(ARGW)N10R10, V12 LAUNCH

The four-color Twist-Lite is a unique indicating light offering four separate color indications on the full display screen of each unit. The different colors are obtained by four individual lamp circuits in the same Twist-Lite unit. Each lamp is furnished with a colored bulb filter to produce the desired indicating color. A prismatic lens arrangement is placed between the indicating lamp and legend plate. The design of the prism has been made to offer maximum uniform light intensity integrated across the full display face with only one lamp illuminated. In this manner, as each of the four lamps is illuminated singly, the legend face is completely flooded with the indicating color as determined by the color of the bulb filter over the energized lamp.

This unit incorporates several special features in addition to those of the Safran standard Twist-Lite. These special items include a high reflective white coating to the housing interior surfaces as well as a white nylon bulb board on the front end assembly.

The use of white reflecting surfaces offers maximum light reflectance for overall intensity on the legend face.

A unique front element is provided on the prismatic lens assembly. This front element has been molded with a clear viewing area surrounded by a black integrally mounted frame. With this arrangement all extraneous light leakage is eliminated from the sides of the lens assembly.

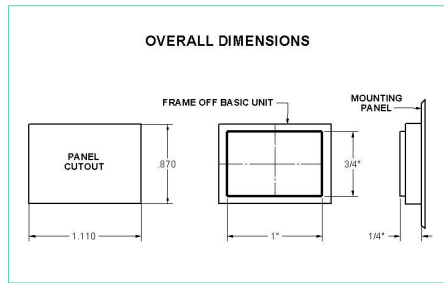
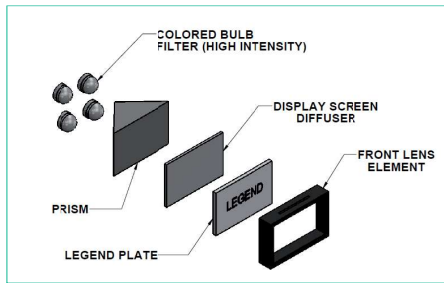

<p>WHEN ORDERED AS A PART OF A COMPLETE UNIT.</p>	<p><b>10E 10 A1C1 F1 J3 L1(A) N10 R10,V13 MISSILE, AWAY</b></p> <p>HIGH INTENSITY COLORED BULB FILTERS</p> <p>LEGEND ARRANGEMENT AND WORDING REQ'D.</p> <p>FOR 4-COLOR TWIST-LITE WITH BRIGHT FINISH HOUSING. ADD (12) FOR 4-COLOR TWIST-LITE WITH BLACK FINISH HOUSING.</p>
<p>WHEN ORDERED AS A SEPARATE ASSEMBLY.</p>	<p><b>10E N10 R10</b></p> <p>FRONT LENS ASSEMBLY (4 PIECE)</p> <p>4-COLOR LENS ASSEMBLY</p> <p>NOTE: THIS ORDER NUMBER CONSISTS OF ONE EACH: PRISM, DIFFUSER, LEGEND PLATE, AND FRONT ELEMENT.</p>
<p>WHEN ORDERED AS REPLACEMENT PARTS.</p>	<p>FRONT LENS ELEMENT _____ <b>10E 535</b></p> <p>DISPLAY SCREEN DIFFUSER _____ <b>10E 536</b></p> <p>PRISM _____ <b>10E 537</b></p> <p>LEGEND PLATE _____ <b>10E 539</b></p> <p>NOTE: LEGEND PLATE NOT ENGRAVED</p> <p>COLORED BULB FILTER (HIGH INTENSITY) <b>10E L1( )</b></p> <p>ADD COLOR LETTER FOR COLOR REQUIRED</p>
<p>ENGRAVED LEGEND ORDERED AS REPLACEMENT PARTS.</p>	<p><b>10E R10,V13 MISSILE, AWAY</b></p> <p>LEGEND ARRANGEMENT AND WORDING REQUIRED.</p> <p>LEGEND PLATE FOR 4-COLOR</p> <p>*MAXIMUM OF THREE LINES OF ENGRAVING ON LEGEND PLATE OF 4 COLOR TWIST-LITE ONLY.</p>



## SWITCH GUARD & RFI SCREEN SERIES 10E & 10H

10EA1C2F2J3L1(AABB)M1N2R1,V16 ON/OFF

### SWITCH GUARD

Full protection against inadvertent switch actuation is provided by a clear plastic cover hinged at the top and spring loaded to the closed position. The attachment may be easily installed in the field on any Twist-Lite. To install, pull out the front end assembly and loosen the housing mounting screws to provide sufficient clearance between the Twist-Lite frame and panel. When properly aligned, the Switch Guard retainer is slipped onto the frame. The order number for the Twist-Lite Switch Guard is **10E534** or **10H534**.

### RFI SCREEN

Added protection against unwanted radiated and conducted RFI passage through the Twist-Lite panel cut-out is attained through the use of a fine-mesh metal screen attached to the lens retainer behind the display screen. The silver-plated beryllium copper screen makes contact with the stainless steel housing in four separate areas. The RFI Screen is available for full, vertical, horizontal, three, or four-way split displays. The RFI Screen and the display screen are installed as an integral part of the front-end assembly during the manufacturing. The Screen may be included as part of either a completed Twist-Lite assembly or a front-end assembly with display screen.

### SPARE PART NUMBERS\*

(Front end assembly with RFI Screen and white Display Screen)

DISPLAY SCREEN	TYPE OF UNIT		
	INDICATOR	SWITCH	HOLDING COIL
FULL DISPLAY	10E or 10H 557	10E or 10H 613	10E or 10H 647
HORIZONTAL SPLIT	10E or 10H 558	10E or 10H 614	10E or 10H 648
VERTICAL SPLIT	10E or 10H 559	10E or 10H 615	10E or 10H 649
3-WAY SPLIT	10E or 10H 560	10E or 10H 616	10E or 10H 650
3-WAY SPLIT	10E or 10H 561	10E or 10H 617	10E or 10H 651
3-WAY SPLIT	10E or 10H 562	10E or 10H 618	10E or 10H 652
3-WAY SPLIT	10E or 10H 563	10E or 10H 619	10E or 10H 653
4-WAY SPLIT	10E or 10H 564	10E or 10H 620	10E or 10H 654

\*Add «H», «V» or «S» to the end of the Unit Part Number when Split Ground for Lamp Circuit shown on Page 7 is required. No letter designation is required for common ground. Example:

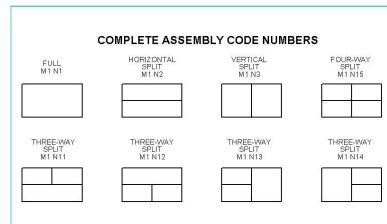
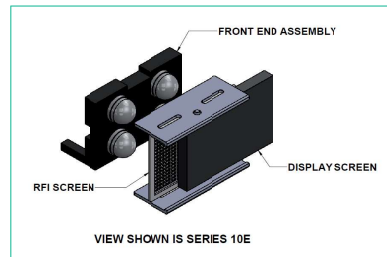
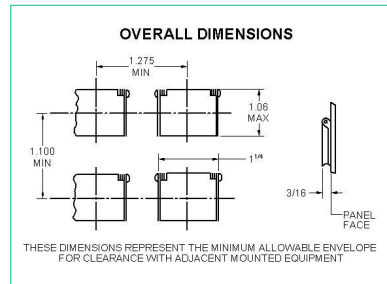
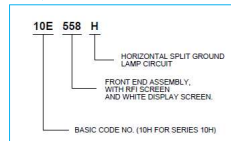

## DRIP PROOF SEAL SERIES 10E & 10H

### EFFECTIVE, SIMPLIFIED 2-PART ASSEMBLY

The Drip-Proof Seal is an effective accessory to the basic Series 10 Twist-Lite unit for applications where adverse environmental conditions could prove destructive to equipment in which push-button switching devices are employed. Comprised of two parts, this assembly provides a more effective seal than other available types. The two parts are (1) a flexible transparent plastic front covered seal and (2) a plastic retainer.

### QUICKLY, EASILY INSTALLED

Installation of the Drip-Proof Seal is easily accomplished during the mounting of the Twist-Lite unit. Before the switch assembly is snapped onto the indicator unit, the retainer is slipped over the indicator unit from the back. It is slid forward as far as it will go to frame the flange of the unit housing.

The Twist-Lite unit is then mounted in the normal manner. After the Twist-Lite has been mounted to the panel, the front seal can be simply pressed into place over the flange of the retainer.

### NO HINDRANCE OF LEGEND READABILITY OR SWITCH ACTUATION

The properties of the front seal yield a virtually transparent, flexible cover that permits free movement of the switching mechanism with the application of normal pressure. Legends can be easily read before or during illumination.

### QUICK ACCESS TO FRONT END ASSEMBLIES

The front seal can be simply removed at any time by snapping it off from the retainer, permitting removal of the front end assembly of the indicator unit for relamping, change of colored lamp filters or for front lens legend replacement. No tools are required for any of the changes.

### NO SPECIAL LEGEND PLATES REQUIRED

Since it is made from clear plastic material, the Drip-Proof Seal can be used with standard Series 10E Twist-Lite reverse engraved front lenses.

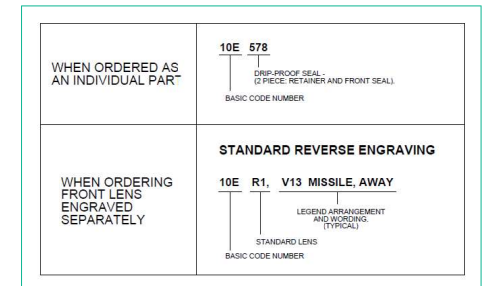
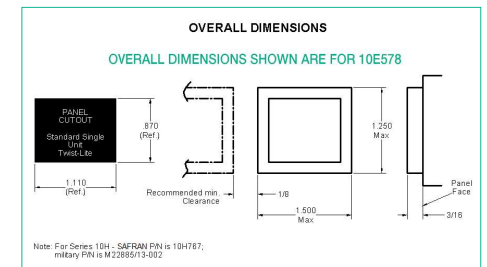



## MASTER CONTROL TEST CAPSULES SERIES 10E & 10H

### 10EA1C1D10F1J1L(AAAA)N1R1,V12 LAUNCH

Components required for Master Lamp Verification are encapsulated in a test control capsule which mounts on spring clips, located on the back of the Series **10E** Twist-Lite unit. This capsule eliminates the need for external circuitry and is available in a wide range of circuits, providing negative and positive test inputs for all available display screen styles. Spring clips are also provided on the back of the capsule, to allow attachment of switch assemblies.

#### ORDERING INFORMATION

The Twist-Lite series **10E** Diode Test Capsule may be ordered as part of a completed assembly or as a replacement part. Both methods of ordering are shown below.

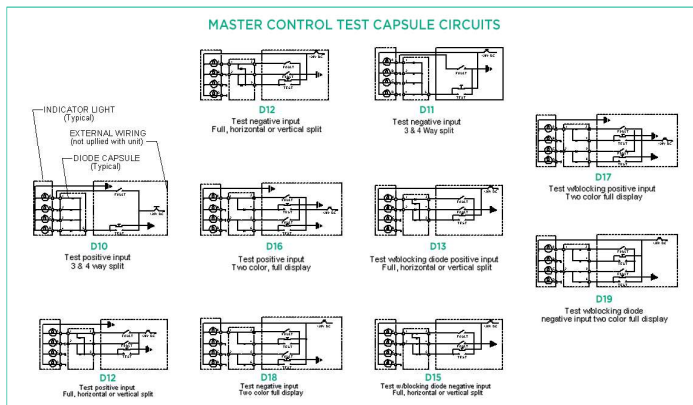
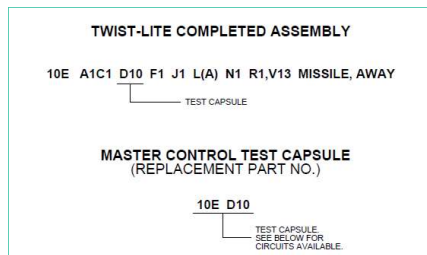
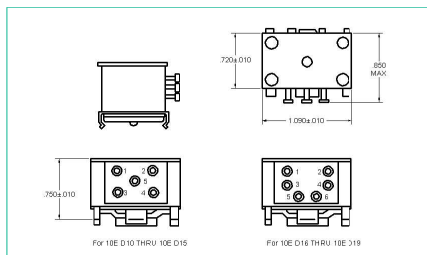

## QUALIFICATION TO MIL-PRF-22885

The Series 10 Twist-Lite Switches have been granted qualification approval to MIL-PRF-22885. To order MIL-PRF-22885 qualified units, the part number should include the letter "H" after the series number 10.

The list of Safran military specification part numbers for the Series 10H Switches is listed on page 5 of this catalog. Additional military specification part numbers for these switches are available upon request. Should you have a need for more information on these Military Qualified Products and its components, please consult your Safran representative or call the factory.

With the collaboration of:  
Publication director: Casandra Pevita  
Editor in Chief: Joe Rivera, Sr. Marketing  
Design and production: Alaina A. Lawrence  
Photo credit: Safran Avionics, Fortida, Safran, Shutterstock, DR  
Printed in United States by Digital Corporate Companies Inc.  
November 2016